

Installation Manual

eCoolPark 1.5 – Ford F450, F550, F600

Developed by: Bergstrom Inc.

Updated 6/2/2026



Bergstrom®



The information contained herein is proprietary to Bergstrom Inc and/or its subsidiaries shall not be reproduced, copied, or disclosed in whole or in part, or used for manufacture or any other purpose, without prior written permission of Bergstrom Inc. The only controlled version is that viewed electronically on the designated Bergstrom intranet site.

Table of Contents

Introduction	0-3
Before You Start	0-5
Parts List	0-9
Tools List	0-12
Installation Procedures	1-1
Overview	1-2
Disconnect Power Source and Reclaim OEM Refrigerant	1-3
eCoolPark 1.5 Unit Mounting	1-4
Run Hoses (Loose)	1-5
Identify OEM Refrigerant Tubing/Hoses and Install T Fittings	1-6
Fitting Assembly	1-7
Connect to Hoses	1-10
Secure Hoses and Connect to Unit	1-12
Leak Check and Charge System	1-14
Checking for Leaks	1-15
Electrical Installation	2-1
Operating Instructions	3-1
Troubleshooting	4-1
Appendix	5-1

Congratulations!

You have chosen the premier no-idle climate control system on the market today – the *eCoolPark XT (1.5)* from Bergstrom Inc.



The *eCoolPark XT* is a powerful 12/24/48 VDC system that keeps the cab compartment cool in hot weather without having to idle the vehicle engine. This system is intended to provide no-idle cooling for the cab. The system consists of an electrified compressor/condenser unit installed generally on the headache rack or mounted behind the cab. The system integrates into the existing A/C refrigerant lines and utilizes the existing evaporator. Check valves and solenoid valves are used to isolate the eCoolPark system from the OEM refrigerant system. It not only dramatically reduces fuel burned but is also extremely environmentally friendly.



WARNING: The eCoolPark unit must remain upright at all times. DO NOT TILT. The refrigerant inlet/outlet at the bottom of the unit should be capped when not in use.

The eCoolPark unit is shipped under pressure. Use caution when removing shipping caps.



This specific set of instructions is intended for use only with a Ford F450, F550, or F600. However, other Ford models may have a similar installation structure. For another vehicle's instructions or for a universal set, contact a Bergstrom employee or visit:

<https://bergstrominc.com/us/manuals-and-support-installation-manuals/>

A typical installation of the eCoolPark system takes between 6 and 10 hours. This manual contains step-by-step installation instructions and is divided into three main sections:

- **Installation Procedures**
- **Electrical Installation**
- **Operating Instructions**

If relocation or reinstallation of any pre-installed equipment is necessary, please refer to the components manufacturer's instructions or safety guidelines for proper installation.

Before starting, we recommend the following to help in the installation process:

1. Lay out all parts check to make sure everything is included. You may have extra hardware after the installation is complete. If you are missing any parts, call 1-866-204-8570.
2. Please keep the condenser/compressor unit in an upright position at all times to prevent damage. If unit has been tipped, place upright for 6 hours prior to running.
3. Be sure you have all the required tools by consulting the "Tools Required" tab.
4. Read through the installation manual before beginning to understand the order of installation.
5. Make sure all workers have proper lighting throughout the install.
6. Make sure to wear proper safety equipment at all times.



Precautions

Installation, service, and repair of these units should be solicited only by trained service technicians who are acquainted with standard service instructions and training material.

All equipment should be installed in accordance with accepted principles and unit installation instructions. Extreme caution should be observed when troubleshooting electrical components. These messages are for your protection and information. Failure to follow these alerted messages may cause bodily injuries to yourself and/or others as well as damages to the specified unit.

Health, Safety, and Environmental Policy

Under any condition Bergstrom Inc. is committed to protecting the health and safety of all working individuals at or visiting our site. We strategize, administer, conduct, and supervise our efforts in agreement with best practice. Hence, we want to ensure all workers have a clear understanding of their accountabilities with that of the company.

Environmental Concerns

Public awareness of and education about the benefits of using green technologies, coupled with energy efficiency, has created renewed interest within the HVAC industry.

When refrigerant is discarded attempt to reclaim and recycle it. To preserve our environment, follow appropriate rules and regulations when disposing of any resources. It is under our obligation to put in place a series of practices and procedures that, when taken together, result in an environmental management system.

Disclaimer of Liability

Descriptions and specifications within this manual were in effect at the time of production. Models and specifications are subject to change.

Picture Symbols

Observe all warning and caution notices posted on equipment and in instructions and/or manuals. Pay special attention to directives prefixed by symbols and signals indicated as “Warning”, “Caution”, and “Note”.

Do not disregard any of these alerts

Warning

This picture symbol with the remark “Warning” refers to the risk of imminent danger and can be vital to one’s health. The message will convey what the hazards are, consequences of those hazards, and/or how to avoid such injury. Under certain circumstances, failure to comply with these instructions can cause severe or life-threatening impairment.

Caution

This picture symbol with the remark “Caution” refers to a hazardous situation for a person and/or the product. Failure to comply with these instructions can cause bodily injuries to yourself and/or others as well as damage to machinery.

Note

This picture symbol with the remark “Note” contains information for use and helpful tips to assist an individual when repairing a specified unit or vehicle.

Precautions for working with HFC134a (R134a) Refrigerant and Polyalkylene Glycol (PAG) Refrigerant Oil

Warning

- Do not breathe A/C refrigerant, oil vapor, or mist. Exposure may cause irritation to the eyes, nose, and throat.
- Instances where there are accidental system discharges; ventilate work area before resuming service.
- For additional health and safety information, contact the refrigerant and oil manufacturers.

Caution

- **The air conditioning system uses HFC134a (R134a) refrigerant and polyalkylene glycol (PAG) refrigerant oil, which are not compatible with CFC-12 (R12) refrigerant, mineral oil, or PVE oil. If the refrigerants or oils are mixed, the compressor may fail.**
- Do not attempt to use R-12 servicing equipment. Failure to follow this statement may result in personal injury or equipment damages.
- Use service equipment that is only U.L listed and certified in which meets the required standards of SAE J2210 to remove HFC134a (R134a) from the air condition system.
- Before testing, please authenticate the HFC134a (R134a) refrigerant in the vehicle system and recycling equipment / recovery tank are contaminate free by using a refrigerant identifier.

Note

The air conditioning system is designed only for certain polyalkylene glycol (PAG) refrigerant oil for HFC134a (R134a) A/C systems and HFC134a (R134a) components. The only recommended oil for this particular system is PAG oil (PAG 46, 100, and 150). The PAG oil is very hygroscopic, meaning it absorbs water. Without appropriate sealing, the oil will become moisture saturated and should not be used.

Note

All equipment must be serviced by trained professionals only.

R134a service equipment and/or vehicle air conditioning systems should not be pressure or leak tested with compressed air.

- Air conditioning system may consist of R134a fluorescent dye to determine leak detection. Examine with a high intensity ultraviolet light system.
- Specified labels on unit will identify systems that contain fluorescent dye.

Note

Follow the handling procedures listed below:

- Only use the specified PAG oil from a sealed container. PAG 46, 100, and 150
- After use, immediately reseal containers of oil.
- To avoid contamination, do not return oil to original container once it has been dispensed. Additionally, never combine oil with other refrigerant oils.
- Do not allow PAG oil to come in contact with styrofoam parts. In such occurrences, damage may result.
- Do not allow PAG oil in contact with vehicle paint. In such occurrences, damage may result.
- In order to diminish the amount of moisture that enters the system, any connection in the refrigerant loop that is open must be closed as soon as possible.
- It is recommended for components that are replaced to have dust caps left in place until the component is ready to be installed in the refrigerant loop.
- Once components are removed from the refrigerant loop they should have dust caps in place as soon as possible in order to limit and minimize moisture intrusion.

Important Safety Notices

Warning

Ill-advised practices, negligence, and/or ignoring warning signs may cause death, personal injury, equipment or property damages.

Before proceeding please read and understand all safety precautions and warnings. The list as follows contains the general safety provisions that must be followed.

Work areas should be dry, well lit, ventilated, and free of clutter such as loose tools, parts, ignition sources and hazardous substances. All personnel must be aware of hazardous conditions that can coexist.

- Wear protective shoes when working. Opened toed shoes are not allowed.
- Rotating parts can cause cuts, mutilation, or strangulation. Be alert at all times when operating machinery.
- When working, do not wear loose-fitting or torn clothing. Additionally, do not wear jewelry. These are hazards that may cause personal injury.
- Before beginning any repairs, disconnect the battery (negative [-] cable) from both battery boxes and discharge any capacitors.
- To prevent accidental engine starting disconnect the air starting motor, if equipped.
- To prevent personal injury or harm to the specified unit place a “do not operate” tag in the operator’s compartment or on the controls.
- Before operating, allow the engine to cool.
- Always use blocks or proper stands to support the vehicle or vehicle components before executing service repairs. It is important that one does not operate on anything that is supported only by lifting jacks or a hoist.
- To reduce the probability of personal injury, use a hoist or get assistance when lifting components that weigh 23 kg [50 lbs.] or more. Make certain all lifting devices such as chains, hooks, or slings are in good condition and are of the correct load capacity. Furthermore, all lifting devices must be positioned correctly. When needed, always use a spreader bar. Also, lifting hooks must not be side-loaded.
- When handling corrosion inhibitors and lubricating oils avoid exposure to eyes and repeated contact to skin for they may contain alkali. In case of contact, immediately wash skin with soap and water. When cases are severe, please contact a physician. Store toxic products and substances out of reach of children.
- Naptha and Methyl Ethyl Ketone (MEK) are flammable and hazardous materials and must be used with attentiveness. Follow manufacture guidelines to ensure safety when handling materials. Store toxic products and substances out of reach of children.
- When operating on a vehicle be attentive and cautious for hot parts on systems that have been turned off, exhaust gas flow, and hot fluids in lines, tubs, and compartments. Direct contact to skin may cause severe burns.
- Always use tools that are in good working condition. Service technicians must be trained and have proper understanding on how to use the tools before administering service.
- When replacing items use the same and/or equivalent fastener part number at all times. Conversely, do not use a fastener of reduced quality if replacement is needed.
- To prevent bodily injury or harm do not perform any repairs when impaired, fatigued or after consuming alcohol or drugs that can impair one’s functioning.
- According to several states and federal agencies within the United States of America it has been evident that used engine oil can be carcinogenic, causing reproductive toxicity. That being said, avoid inhalation of vapors, ingestion, and prolonged contact with used engine oil.
- Be mindful that liquefied petroleum gas is denser than air and can accumulate near the floor, in slumps, and low-lying area.
- Close the manual fuel valves prior to performing maintenance and repairs and when storing the vehicle inside.
- **California Proposition 65 Warning** – Diesel engine exhaust and some of its constituents are known to the state of California to cause cancer, birth defects, and other reproductive harm. To request more information regarding the chemical exposures that are the basis of the warning, contact the manufacture of the product.



Technicians who repair or service motor vehicle air conditioners must be certified by Section 609 (MACS)

Section 609 of the 1990 Clean Air Act also established an important statutory structure to control the release of refrigerants from motor vehicle air conditioners into the atmosphere. Any person repairing or servicing motor vehicle air conditioners for consideration must properly use refrigerant recycling equipment that has been approved by the EPA.

Technicians who repair or service motor vehicle air conditioners for consideration must be trained and certified by an EPA-approved technician training and certification program. Technicians who repair or service MVAC-like appliances must always be certified by an EPA-approved 609 program.

Under Section 609 of the Clean Air Act, EPA-approved technician training and certification programs provide education on the proper use of MVAC servicing equipment, the regulatory requirements of the Clean Air Act, the importance of refrigerant recovery, as well as the effects of improper handling of refrigerants on the ozone layer and climate system. To be certified, technicians must be trained by an EPA-approved program and pass a test demonstrating their knowledge in these areas. Section 609 certification is required to service any motor vehicle air conditioning system for consideration (e.g., payment or bartering), regardless of the refrigerant used in the system.



WARNING: The eCoolPark unit must remain upright at all times. **DO NOT TILT.** The refrigerant inlet/outlet at the bottom of the unit should be capped when not in use.

The eCoolPark unit is shipped under pressure. Use caution when removing shipping caps.

Ford Kit – 1002711948 (12V), 1002997602 (24V/48V)

<i>Part Number</i>	<i>Description</i>	<i>Quantity in Kit</i>
1002725835	eCoolPark Unit 12V	Sold Separately
1003098208	eCoolPark Unit 24V	Sold Separately
1004279160	eCoolPark Unit 48V	Sold Separately
1002688919	Decal – eCoolPark Charge Blank	2
1000021997	Fitting, #6 90 Female o-ring	1
1002784746	Fitting, Steel – 90 Deg CV to 8H	1
1000021465	Fitting, Steel – ATCO 5/8-18	1
1002783102	Fitting, Steel – Check Valve - 6	1
1002907693	Fitting, Steel – Check Valve - 8	1
1002908950	Fitting, Steel – Kit CV 90	1
1002907156	Fitting, Steel – Kit CV Straight	1
1002631947	Fitting, Steel #12-12-8 T	1
1002631959	Fitting, Steel #14-14-8 T	1
1001260067	Hose, #6 Bulk 4890 Refrig	25 ft.
1001260070	Hose, #8 Bulk 4890 Refrig	25 ft.
1003041531	Kit, HVAC – CT 8-8-6 90	1
1003042113	Kit, HVAC – Fitting 45,45,90,90 T ¾ x ¾ x 1/2, T 5/8 x 5/8 x 1/2	1
1002777315	Kit, HVAC – Spare Parts	1
1002702195	Kit, HVAC – Temp Sensor	1
1002705844	Kit, HVAC CV to #8 x 45 deg	1
1002694868	Kit, HVAC Hose Routing	1
1003041539	Kit, Steel – CV & Dis Tee 90	1
1002973160	Lubricant – PAG 46-H 4oz	1
1002885669	Wire Harness – eCool 24V w/ 12V En Main Vehicle	1 (24V/48V ONLY)
1002368371	Wire Harness – Ecool Ignition	1
1002547762	Wire Harness – Main Vehicle Comp Cond	1 (12V ONLY)
1002609482	Wire Harness – OBDII CAN Jumper	1

**For Missing Parts:
Bergstrom Technical Service Line: 1-866-204-8570**

Electrical Kit - #1002407230

640377	Bag, 3 x inch Static	2
640378	Bag, Plain Plastic 12 x 12	1
1000247779	Butt Connector Step 14-16 to 18-20	2
1002404448	Electrical Comp, Fuse, 5A Micro2	1
1002404450	Electrical Comp, Light, Indicator	1
1002404439	Electrical Comp, Micro2 Add-a-Fuse	1
B223109	Fuse Holder	2
1000174286	Fuse holder, Mega Bolt-on	1
B223106	Fuse, 20A	1
1000230085	Fuse, 5A ATO	2
1001268553	Fuse, Mega 80A Red	1
520260	Grommet, Flexible	2
651459	Iso-Relay, 12V	2
600283	Screw, Self-Drill	2
1002618099	Switch – Rocker, eCoolPark – 12V	1
1000247777	Terminal 3/8” Ring 14-16 AWG Sealed	3
1000247778	Terminal 3/8” Ring 18-20 AWG Sealed	4
670137	Terminal Ring 3/8 4 AWG	2
670136	Terminal Ring 5/16 4 AWG	4
1001268595	Terminal, Electric – 12-10 Butt Splice	1
B360113	Tie - Plastic	50
651462	Tubing Heat Shrink	6

eCoolPark Electrical Service Kit - #1002839006 (Only 1 per upfitter needed)

1002519049	Printed Material Website Details	1
1002839003	120 Ohm Termination Resistor	2
1002839004	Peak USB Adaptor	1
1002839005	Wire Harness – eCoolPark Service	1

Refrigerant Hose Clamp Ratcheting Plyers (Only 1 per upfitter needed)

1001458325	Hose Crimp Plyers	1
------------	-------------------	---

**For Missing Parts:
Bergstrom Technical Service Line: 1-866-204-8570**

This list is subject to change. Some tools may not be used.

- Drill Bit Set
- Hole Saws (up to 2")
- Electric/Air Drill
- Screwdrivers/Assorted Bits (Flat and Phillips)
- Impact Gun
- Air Saw/Jigsaw (Sheet Metal/Steel Cutting)
- Torx Head Bit Set (T20 and T25)
- Metric and SAE Wrenches
- 1/4" and 3/8" Drive Ratchets
- Metric and SAE Socket Set
- Wire Cutters (up to 2/0)
- Terminal Crimpers
- Wire Strippers (up to 2/0)
- Razor Knife
- Painters Tape
- Snake Tool
- Electrical Tape
- Hose Cutters
- #4 Professional Grade Cable Crimpers
- Work Light
- Torque Wrench up to 150 in/lbs.
- U-barrel Crimpers
- Pop Rivet Gun
- Deutsch Crimpers
- Step Bit
- Refrigerant Hose Clamp Ratcheting Pliers
- Refrigerant Machine or the Following:
 - Tank of Virgin R-134a
 - Refrigerant Scale
 - Vacuum Pump
 - Gauge Set with Hoses
 - Recovery Machine



Section 1

Installation Procedures

eCoolPark XT

Ford

Installation Manual





The installation of this no-idle A/C system is done in several parts:

- The eCoolPark unit includes a compressor, a condenser, a condenser fan, and an ECU (electric control unit). It is installed on the exterior of the vehicle on the utility rack.
- The OEM refrigerant lines of the vehicle are altered using “T” fittings and hoses are run from the T’s to the eCoolPark unit.
- Electrical harnesses are routed between the eCoolPark unit, power source, and driver compartment.

It is important that the technician completing this installation read through this manual and plan out the steps forthcoming. **Certain mistakes like cutting hoses to short or drilling into refrigerant hoses can cause long installation delays and/or component damage.**

Typical Hose Routing Preview



The following steps will provide a description of the procedure outlined above in detail.

1. Disconnect Power Source and Reclaim OEM Refrigerant

- a. Disconnect the desired power source for the duration of the install and turn the vehicle off. The vehicle main start battery can remain connected.
- b. Reclaim the existing refrigerant in the OEM system using a machine or refrigerant reclamation components.
-  c. Reclamation should be done by a Section 609 (MACS) certified technician.
- d. If refrigerant machine equivalent is not available, components needed include an R-134a recovery machine, a recovery tank, and a gauge set with SAE hoses.



Figure 1.1: Robinair Machine



Figure 1.2: Recovery Machine



Figure 1.3: Gauge Set and Recovery Tank

2. eCoolPark XT Unit Mounting

- a. Mount the provided shelf brackets to the eCoolPark unit using the provided bolts with washers.
- b. Below show a couple examples of mounting locations with brackets. Ideally the unit is as close to the cab as possible, like the pictures show.
-  c. Mount the unit plus brackets to the vehicle using the provided hardware. Unit is heavy (~50 lbs.).
- d. **The condenser fan side of the eCoolPark unit should be pointing to the rear or outside of the vehicle. There should be at least a foot of open space external to the condenser fan.**



Figure 1.4: eCoolPark Mounted

3. Run Hoses (Loose)

- ❗ a. Locate the 2 different sized hoses in the kit and wrap a large section (enough to run under the vehicle to the engine bay) together with heat shield tape (figure 1.5 and 1.7). **Tape the ends of the hoses with masking tape to avoid contamination.**
- b. The hoses will be routed starting at the eCoolPark unit, run under the vehicle, and up into the engine bay. Preferably using existing OEM lines to secure.
- c. The hoses should be wrapped in heat shield tape completely in-between the unit and engine bay.
- ❗ d. Once wrapped, route hoses as described in step b. Vehicle technicians should identify the best way to route these hoses. Stay away from hot components such as exhaust.
- e. Once routed from eCoolPark unit to engine bay, leave hoses loose until later in the installation.



Figure 1.5: Hoses Wrapped in Heat Shield Tape



Figure 1.6: Hoses Routed into Engine Bay

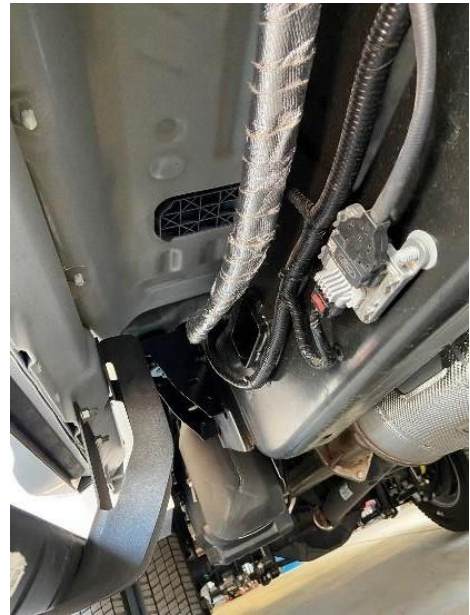

Figure 1.7: Hoses Routed Under Vehicle

4. Identify OEM Refrigerant Tubing/Hoses and Install T Fittings

- Take a minute to study the schematic shown in figure 1.8. Note the T locations in which the eCoolPark system uses to access the OEM refrigerant system.
- Identify the tubes where the T's will be inserted. These will be the compressor discharge line (compressor to condenser) and the compressor suction line (evaporator TXV to compressor).
- Confirm that the OEM discharge line section of hose is suitable for the fittings provided in the Bergstrom kit. Hose should be Galaxy 4890/4880/4826 or Eaton GH001. If not labeled, measure the ID and OD and consult figure 1.12.
- Assemble the discharge T fitting and check valves and mockup the T solution on the suction and discharge section of tube before cutting. Page 1-7 shows the assembly process. Page 1-8 shows the T's inserted into the removed lines.
- The discharge line will have a premade hose T fitting inserted into the hose on the line. A check valve is attached to the T fitting and is installed on the OEM compressor side of the fitting.
- The suction line will have a hose T fitting inserted in the hose on the suction line.

The arrows on the check valves must point in the direction of flow

1.5 eCoolPark Schematic

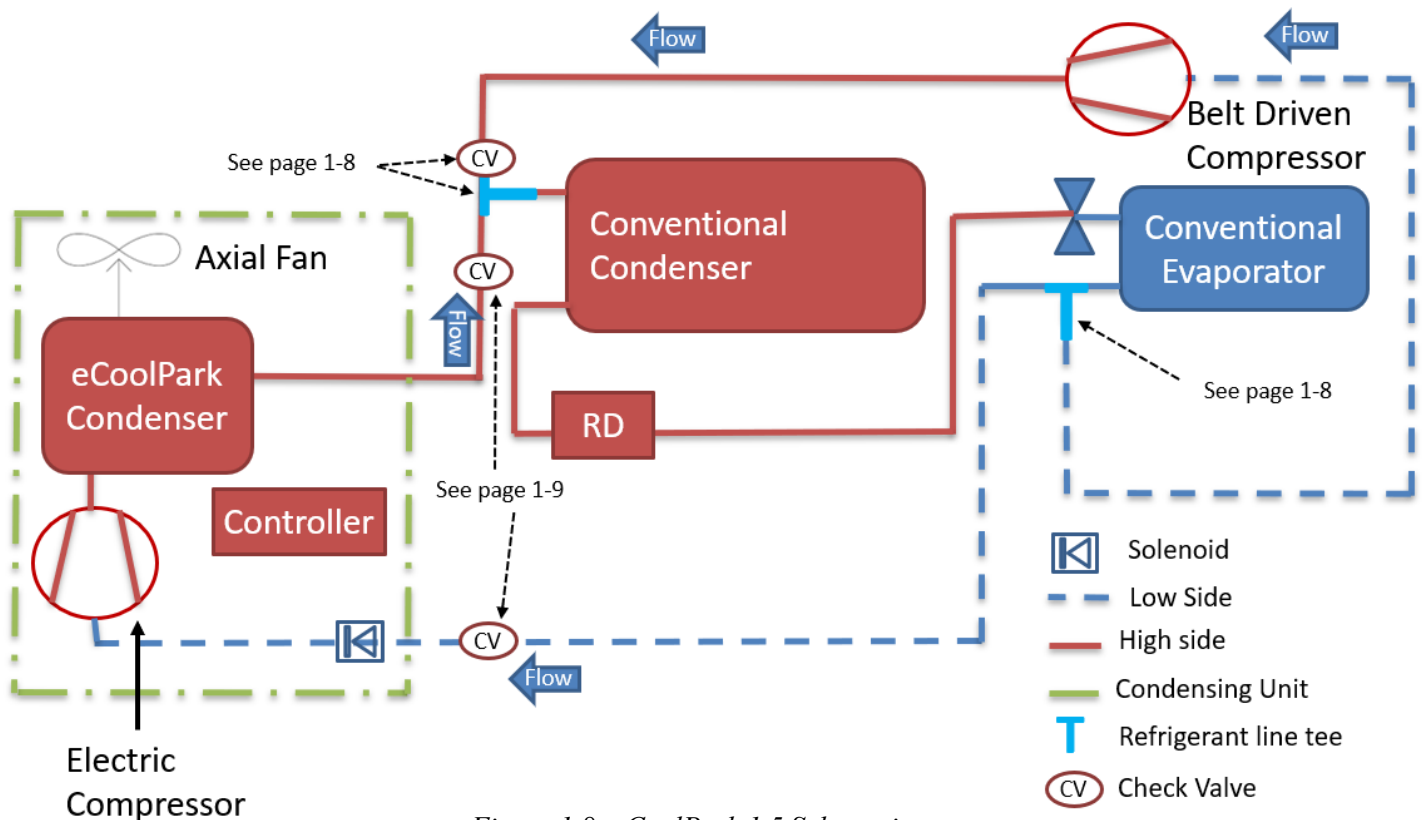
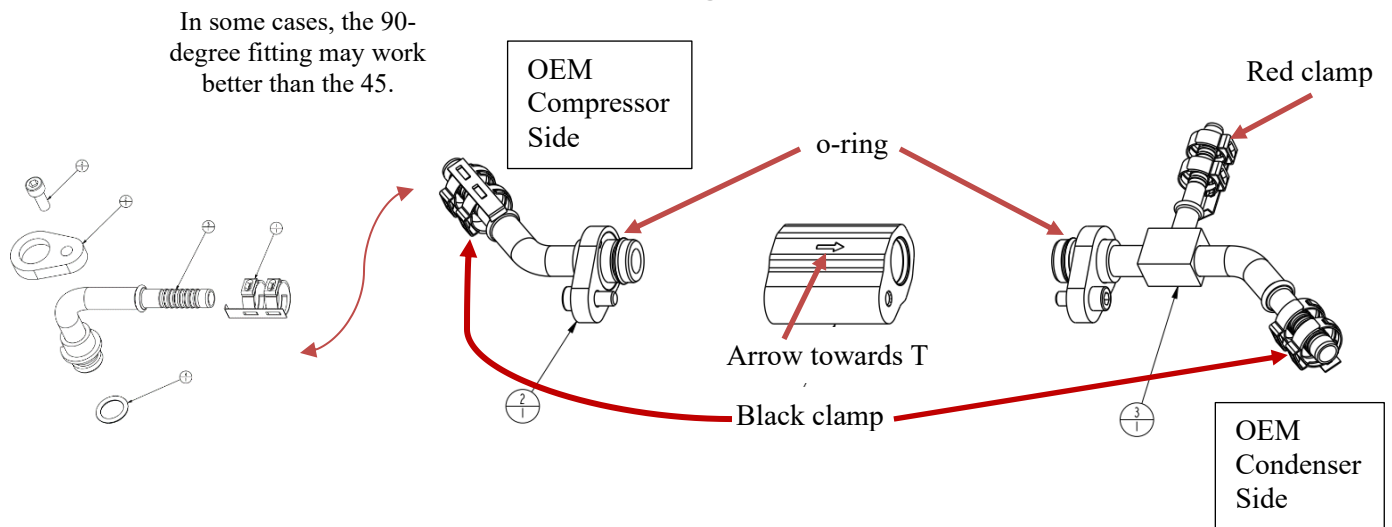

Figure 1.8: eCoolPark 1.5 Schematic

Assemble Discharge T Fitting and Check Valves

Assemble the discharge T fitting and check valves as shown. All fittings are bagged with required o-rings and hardware. Be sure to attach o-rings to check valve fittings and add a small amount of oil to lubricate their assembly. Torque Allen bolts to 7 Nm (62 inch-lbs). Fittings will still rotate inside check valve assembly when tightened.

Discharge T



Check Valves

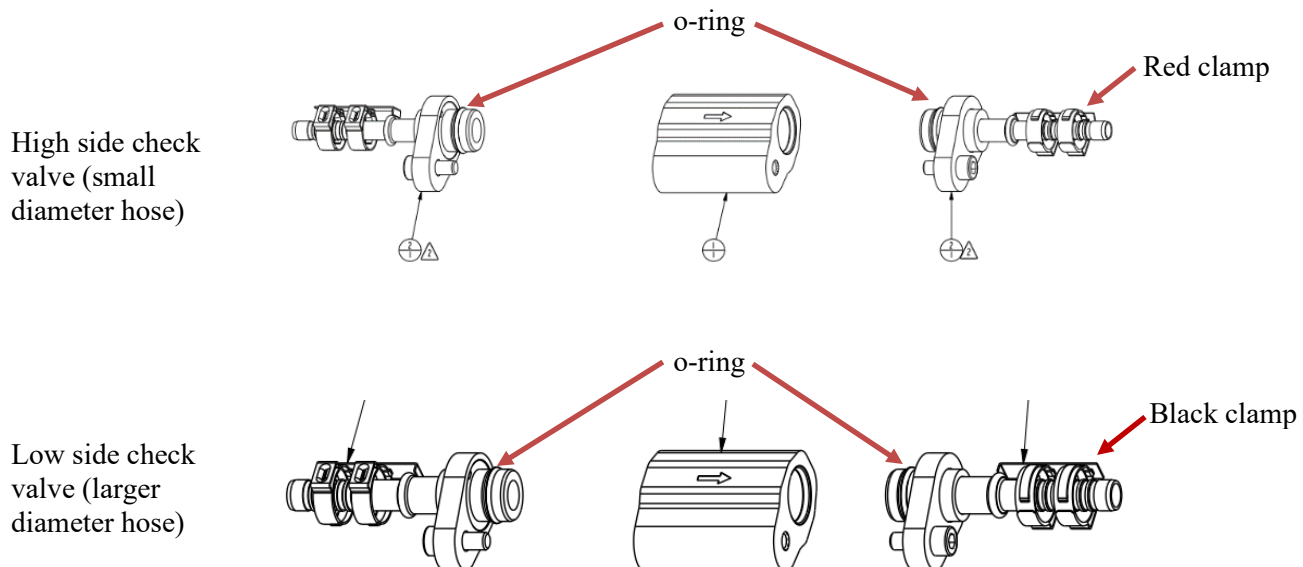

Suction Line

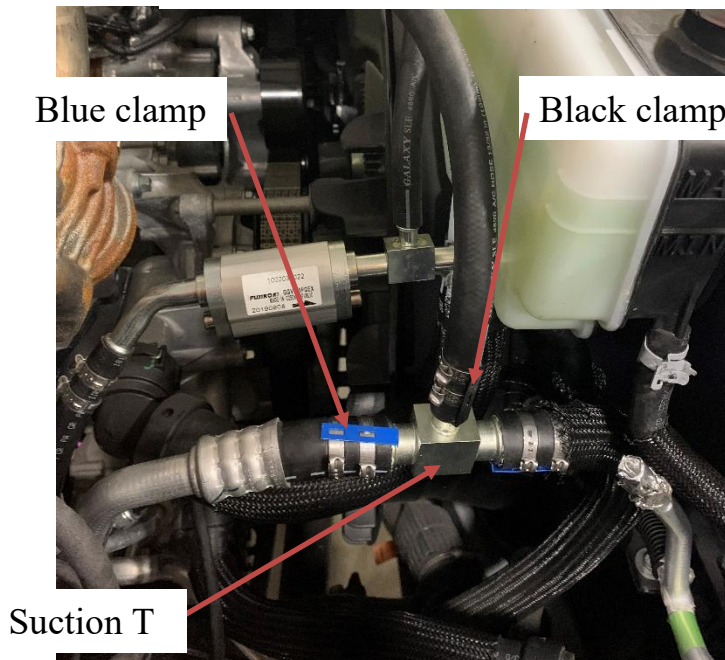

Figure 1.9: Suction T In Vehicle

Mockup the T fitting on the hose and use a marker to mark the hose at the end of the barb fitting. Cut the hose and insert fitting into hose using oil lubricant.

Make sure to insert hose clamp before attaching hose!!!

Discharge Line

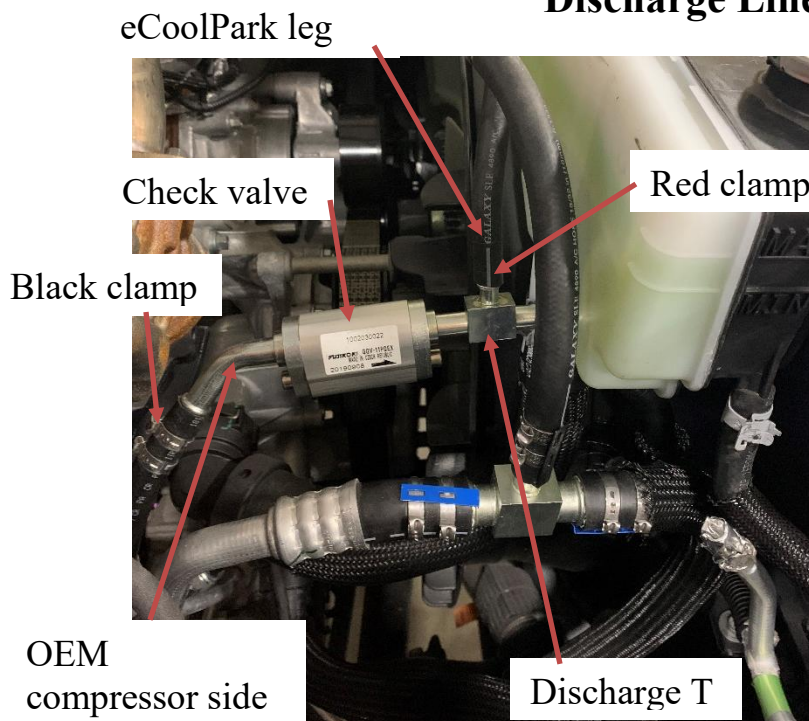

Figure 1.10: Discharge T In Vehicle

Mockup the T fitting on the hose and use a marker to mark the hose at the end of the barb fitting. Cut the hose and insert fitting into hose using oil lubricant.

The check valve will insert on the OEM compressor side. Leave the eCoolPark leg of the T fitting in an upwards position, **NOT DOWN**.

Make sure to insert hose clamp before attaching hose!!!

Check Valves

1.5 eCoolPark Schematic

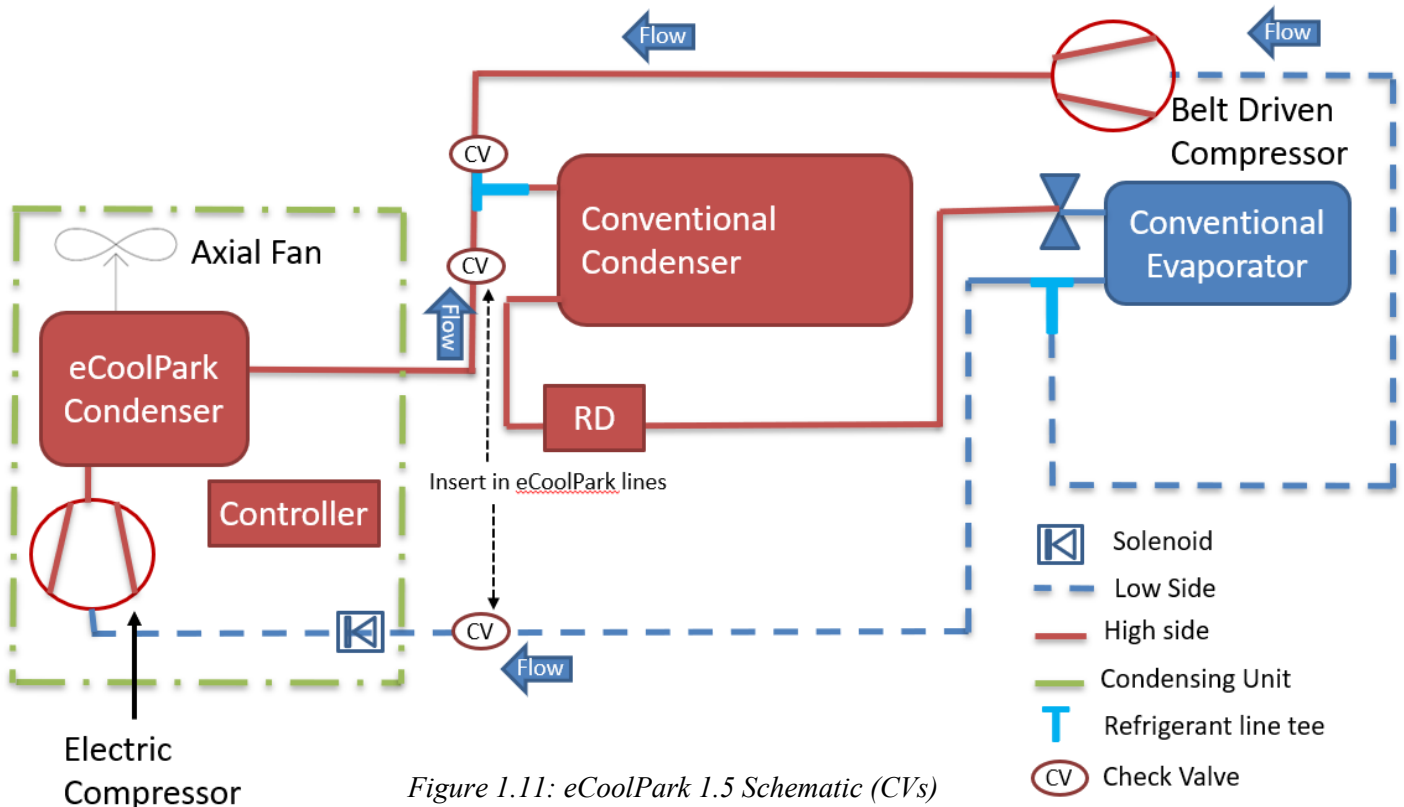

Figure 1.11: eCoolPark 1.5 Schematic (CVs)

There are a total of 3 check valves inserted into the system. One is attached to the new discharge T fitting and should have been inserted with the previous instruction. The other two check valves are inserted into the hoses of the eCoolPark section using straight hose fittings. Insert the 2 check valves in the eCoolPark hoses using the provided #6 & #8 straight check valve hose fittings. Page 1-7 shows the assembly with the correct color hose clamps.

Insert the discharge check valve close to the T fitting (in the engine bay or close to it) and the suction check valve close to the eCoolPark unit (near the eCoolPark compressor unit). Arrows on check valves must point in direction of flow.



Figure 1.12: Example CV in Discharge Hose

5. Connect to Hoses

- a. Connect the T's to the loose hose ran in step 3. Before cutting, be wary of routing – mock up before cutting. Observe where hoses will secure and avoid very hot components. Be sure there are no kinks in the hose.
-  b. Use hose clamps to secure the hoses to the T fittings. Use the ratcheting tool provided by Bergstrom. Correct procedure is shown in figure 1.21.
- c. Wrap hose in heat shield tape where necessary (if up against component). Wrap check valve and secure using zip ties.
- d. If you have any concerns about the install of these fittings or are unsure of the correct steps to take, consult a Bergstrom employee at 866-204-8570.

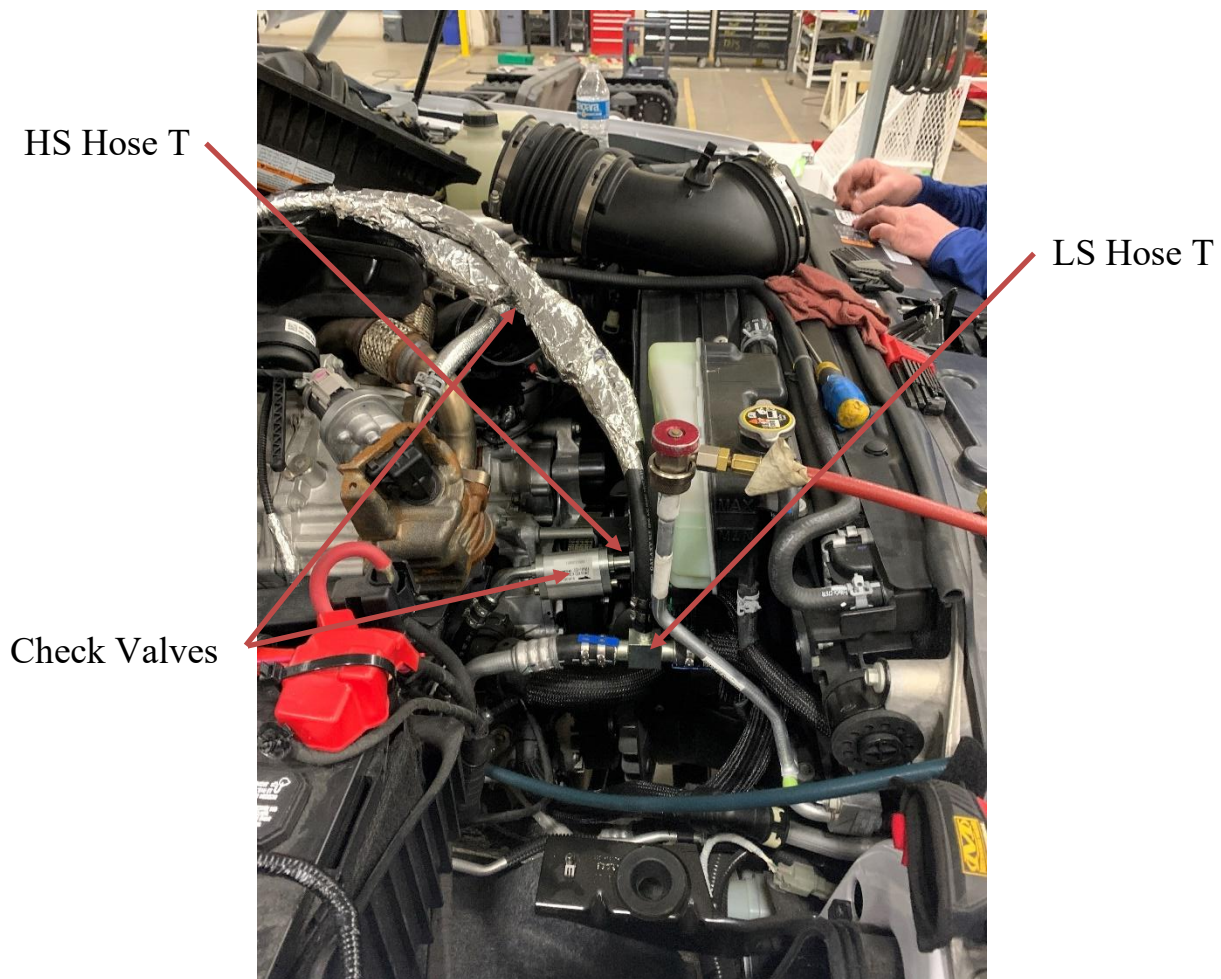

Figure 1.13: Finished A/C Hose Alteration



The arrows on the check valves must point in the direction of flow

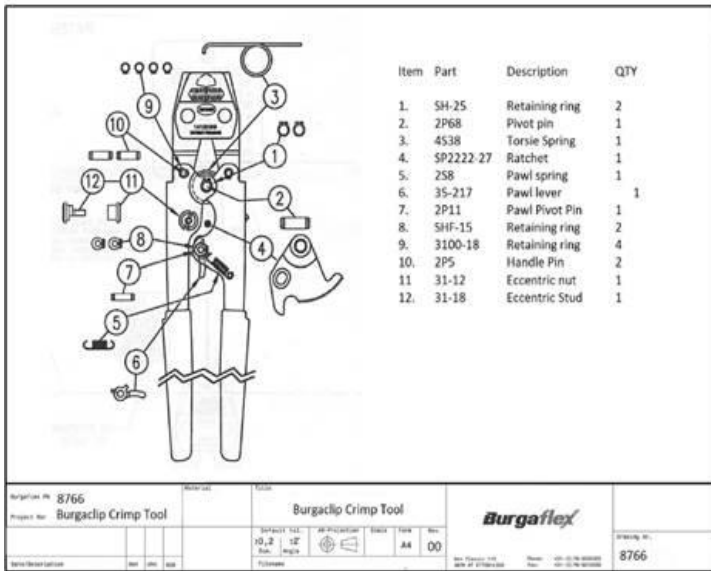

Figure 1.14: Ratcheting Refrigerant Hose Crimpers



Figure 1.16: Hose Clamp Color Code

Length: 50 Ft.	Hose Inner Diameter: 5/16" (7.9mm)	Hose Outer Diameter: 3/4" (19.1mm)	2610001
Hose Size: No. 6			550307
Length: 50 Ft.	Hose Inner Diameter: 13/32" (10.3mm)	Hose Outer Diameter: 29/32" (23mm)	2610002
Hose Size: No. 8			550308
Length: 50 Ft.	Hose Inner Diameter: 1/2" (12.7mm)	Hose Outer Diameter: 1" (25.4mm)	2610003
Hose Size: No. 10			550309
Length: 50 Ft.	Hose Inner Diameter: 5/8" (15.9mm)	Hose Outer Diameter: 1 1/8" (28.6mm)	2610004
Hose Size: No. 12			550310
Length: 825 Ft.	Hose Inner Diameter: 5/16" (7.9mm)	Hose Outer Diameter: 3/4" (19.1mm)	2610001-DS
Hose Size: No. 6			1002300977
Length: 725 Ft.	Hose Inner Diameter: 13/32" (10.3mm)	Hose Outer Diameter: 29/32" (23mm)	2610002-DS
Hose Size: No. 8			1002301587
Length: 700 Ft.	Hose Inner Diameter: 1/2" (12.7mm)	Hose Outer Diameter: 1" (25.4mm)	2610003-DS
Hose Size: No. 10			1002301589

Figure 1.15: Hose ID/OD

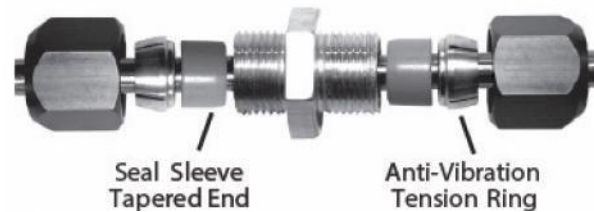

Figure 1.17: Compression T

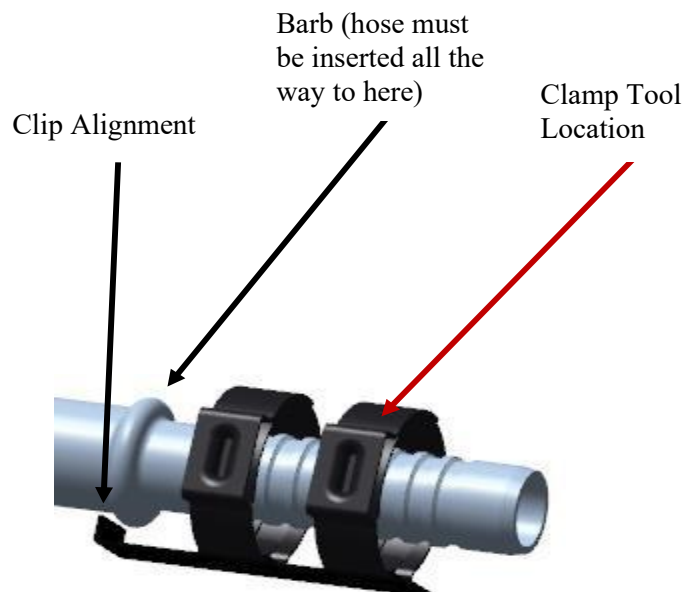

Figure 1.18: Hose Clamp Procedure

6. Secure Hoses and Connect to Unit

- a. The loose hoses in the engine bay should now be connected to the refrigerant T's. Starting in the engine bay, secure the hoses down to the bottom of the vehicle, along the rail or OEM lines, and up to the unit. Hoses should not rub against even a smooth surface. Hoses should not be up against sharp or hot surfaces. Figure 1.19 shows an example of how **NOT** to leave hoses.
- b. Use p-clamps and/or zip ties to secure the hoses firmly.
- c. If without a refrigerant machine: Insert 3 ounces of PAG 100 oil into system via loose hoses.
- d. Both eCoolPark side check valves should have been inserted into the hose. Make sure to wrap them both with heat shield tape and find a way to secure it whether it's zip tied to other lines/electrical or p-clamped.
- e. Run the hoses up to the unit where they will connect to the provided fittings. Mockup the fittings on the unit to determine the correct length of hose to cut and the proper orientation/rotation.
- f. Use the provided solenoid hose fitting and female nut fitting to connect the hoses to the unit. Clamp down the hoses and tighten the Allen and nut.



Figure 1.19: Hose Rub (NOT ACCEPTABLE)

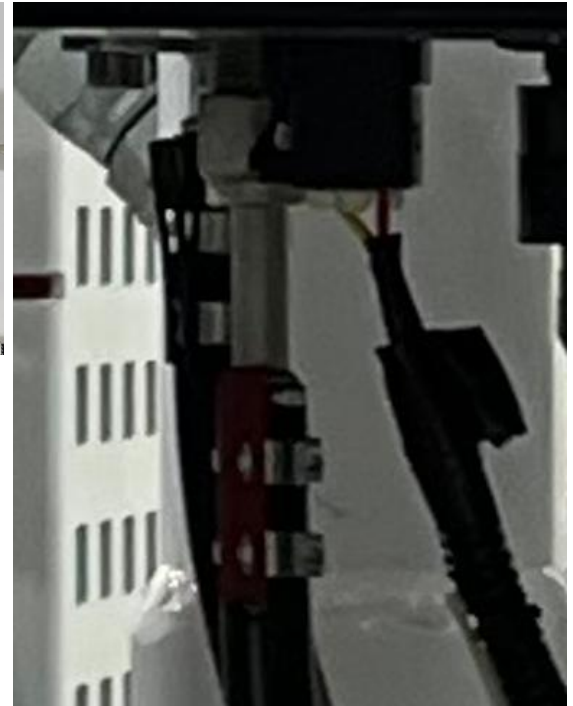

Figure 1.20: Bottom of eCoolPark Unit

AIR-O-CRIMP Fittings

AIR-O-CRIMP Assembly

Cut or trim the hose.

Cut or trim the hose to the desired length using the kwikcut hose cutter. The cut should be made square to the hose length.



Assemble the clamp.

Assemble the clamp assembly onto the hose with the locator tab positioned approximately where the fitting groove will be when the fitting is assembled.



Apply refrigerant oil.

Apply a small amount of refrigerant oil (PAG or Ester) to the fitting barb and o-rings (optional). Assemble the fitting into the hose until hose touches the ramped step on the fitting. Adjust the clamp assembly so the tab on the locator "snaps" into the groove of the fitting.



Crimp clamps.

Using the air crimp gun or the manual crimp pliers, crimp each clamp separately.

Caution: If using the manual pliers, make sure that there is a metal to metal contact of the clamp ear when the crimp is made. There will be a slight amount of spring-back of the clamp ear when the crimp pliers are released. Failure to fully close the clamp may result in refrigerant leaks.



Locator comes off.

The locator will "pop off" after the second clamp is crimped and can be discarded. The result is a clean appearance and a reliable assembly.



Note: Use ratcheting style hose clamp pliers. Use of the non-ratcheting style may cause leaks in the system.

Figure 1.21: Air-o-crimp Assembly Instructions

7. Leak Check and Charge System



- a. Vacuum the system for 30 minutes. Use of a refrigerant machine equivalent is suggested. Additionally, a standalone vacuum pump may be used with a gauge set.
-  b. **BE SURE TO VACUUM FROM BOTH CHARGE PORTS (HIGH AND LOW SIDE).**
- c. Close quick disconnect fittings and leak check system by letting it sit for 30-40 minutes. Mark the pressure on the low side before and after the allotted time. If the pressure does not change after 30 minutes, the system is leak free! If the pressure does change, refer to page 1-12 on searching for a leak in the system before proceeding.
-  d. Charge the system with the factory charge + 10 oz. of virgin R-134a (consult vehicle refrigerant tag) using a refrigerant machine. Insert 3 oz. PAG 100 oil (plus any oil that was removed in the initial evacuation of the OEM system) with the charge.
- e. If a refrigerant machine is not used, you will need to complete Section 2 – Electrical before charging.
- f. For without a refrigerant machine – use a virgin tank of R-134a, a scale, and gauge set to charge the system on the low side. Once you charge with about 3-4 ounces, run the eCoolPark unit to suck in the rest of the refrigerant.
-  g. **CYCLE OEM AND eCoolPark SYSTEM 2-3 TIMES TO SPREAD REFRIGERANT.**
- h. Attach the eCoolPark charge sticker (#1002688919) over or near the OEM refrigerant sticker and write the charge level.



Figure 1.22: Robinair Machine



Figure 1.24: Tank of R-134a



Figure 1.23: Refrigerant Scale

8. Checking for a Leak

- a. There's a leak! First go back through all of the previous work completed during the install and check to make sure every nut, bolt, clamp, etc. is torqued to specification.
- b. Run the vacuum test again after tightening everything.
- c. Still have a leak? Charge the system with a small amount of refrigerant (1-2 oz.).
- d. Then, use a refrigerant sniffer tool to check all the connections in the system. The most common spot for a leak will be the o-rings in select fittings.
- e. Repair the leak spot.
- f. Repeat the vacuum test to assure there is no leak in the system.



Figure 1.25: Refrigerant Sniffer

Section 2

Electrical Installation

eCoolPark XT

Ford

Installation Manual



1. Locate Electrical Harnesses

- a. There should be 2 main harnesses and a small jumper harness included in the kit
- b. Main vehicle harness, Ignition harness, and a small CAN jumper harness.
- c. Connect the main eCoolPark harness to the unit (round and square Deutsch/Amphenol).



Figure 2.1: eCoolPark Vehicle Harness



Figure 2.2: Ignition Harness

2. Routing Vehicle Harness

- a. Route the power and ground 4 AWG cables and the 18 AWG 12/24 VDC remote (labeled as 12 or 24/48 V REM) in the vehicle harness to the desired power source. The power source may be a converter, power pack, or battery.
- b. Secure the harness along refrigerant lines if possible or use zip ties and p-clips to secure it to the vehicle.
- c. Route the 6-way square Deutsch connector branch of the vehicle harness starting at the unit, down under the vehicle, into the engine bay, and through the firewall into the compartment under the steering wheel. Use of the refrigerant hoses routed in the previous section is ideal.
- d. Make sure the hole made to get through firewall is sealed with grommet or equivalent. Un-pining the connector may be necessary. Take a picture of the pinout and record the colors and their respective pin locations before disconnecting.
- e. Install the provided fuse holder with fuse in the up fitter's desired location near the power source. Cut the 4 AWG power cable to length and attach it to one end of the fuse holder. Leave the other end open for now.



Figure 2.3: 6-way Deutsch Branch



Figure 2.4: 12 V Remote Branch of Vehicle Harness



Figure 2.5: Fuse Holder with Fuse

3. Ignition Harness Connections (Driver Compartment)

- a. Connect the 6-way Deutsch that was routed through the firewall to the 6-way Deutsch on the ignition harness. Position the connection somewhere that is accessible in the future.
- b. Unbolt the OEM OBD2 connector from the vehicle trim and connect to OBD2 jumper harness from Bergstrom. Connect the 2-way connector on the CAN jumper harness to the compatible 2-way connector on the ignition harness. Your vehicle may have a different CAN connection than OBD2. Use whatever CAN jumper harness is provided.
- c. Locate a B+ continuously powered fuse (always 12 VDC, even with engine off – consult vehicle manual) in the vehicle fuse box. Splice the orange “fused v-bat” from the ignition harness to the “add-a-fuse” provided in the kit. Attach the add-a-fuse to the located hot fuse. Place the existing fuse and provided 5 Amp fuse in the add-a-fuse.
- d. Cut holes in the up fitter’s desired location for the indicator light and the rocker switch, both of which are provided in the kit.
- e. Route both of their harnesses up though the under the steering wheel compartment and connect them to the light and switch.



Figure 2.6: Indicator Light and Harness Connection



Figure 2.7: Fused V-bat

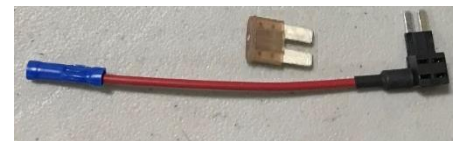

Figure 2.8: Add-a-fuse

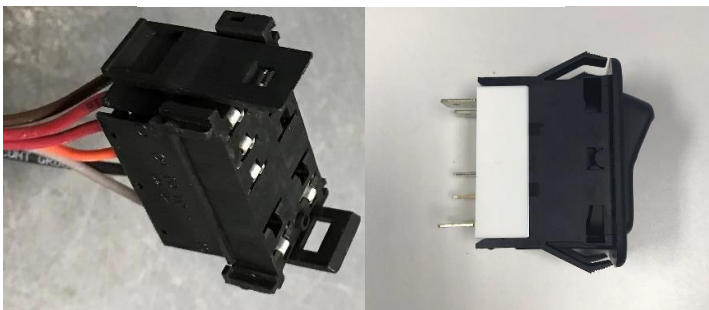

Figure 2.9: Rocker Switch, Harness Connection, and Completed Install Cosmetic

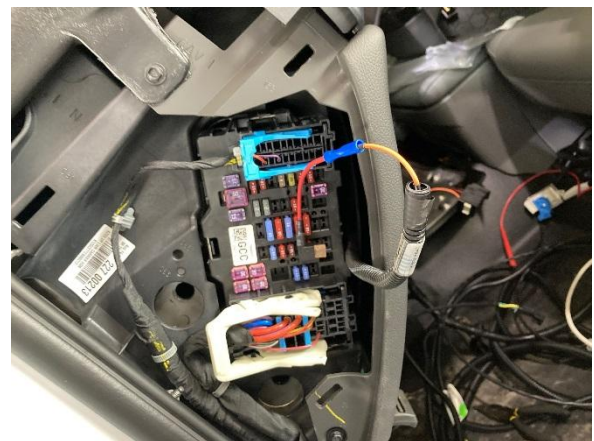

Figure 2.10: Completed Add-a-fuse

4. Ignition Harness Connection

- a. Connect the air temperature sensor provided in the kit to the 2-way compatible connector on a branch of the ignition harness. Secure the sensor in an area close to the recirculation duct.
- b. The dimmer branch of the harness is optional and should be connected to any dash light power source if needed. OPTIONAL
- c. If auto start/stop is installed and interfaced with eCoolPark, connect the “Enable” branch of the ignition harness to the corresponding output signal of the controller. Also, attach a relay to the relay holder on one of the branches of the ignition harness. And last, attach the “Ground IF” branch of the main vehicle harness to power source negative. OPTIONAL



Figure 2.11: Dimmer

5. Electrical Connection

- a. Connect the open side of the main 80 Amp fuse holder to the positive side of the power source using 4 AWG cable and the provided 4 AWG ring terminals.
- b. If power source is a battery, use the provided 18 AWG butt splice to splice in a fuse for the 12 or 24/48 Volt remote sense. Then connect to the positive side of the power source using the provided 14 AWG ring terminals.
- c. Connect the negative 4 AWG from the eCoolPark unit to the negative side of the power source using the provided 4 AWG ring terminals.



Figure 2.12: Remote Sense Fuse Holder



Figure 2.13: Ring Terminals



Figure 2.14: Butt Splices

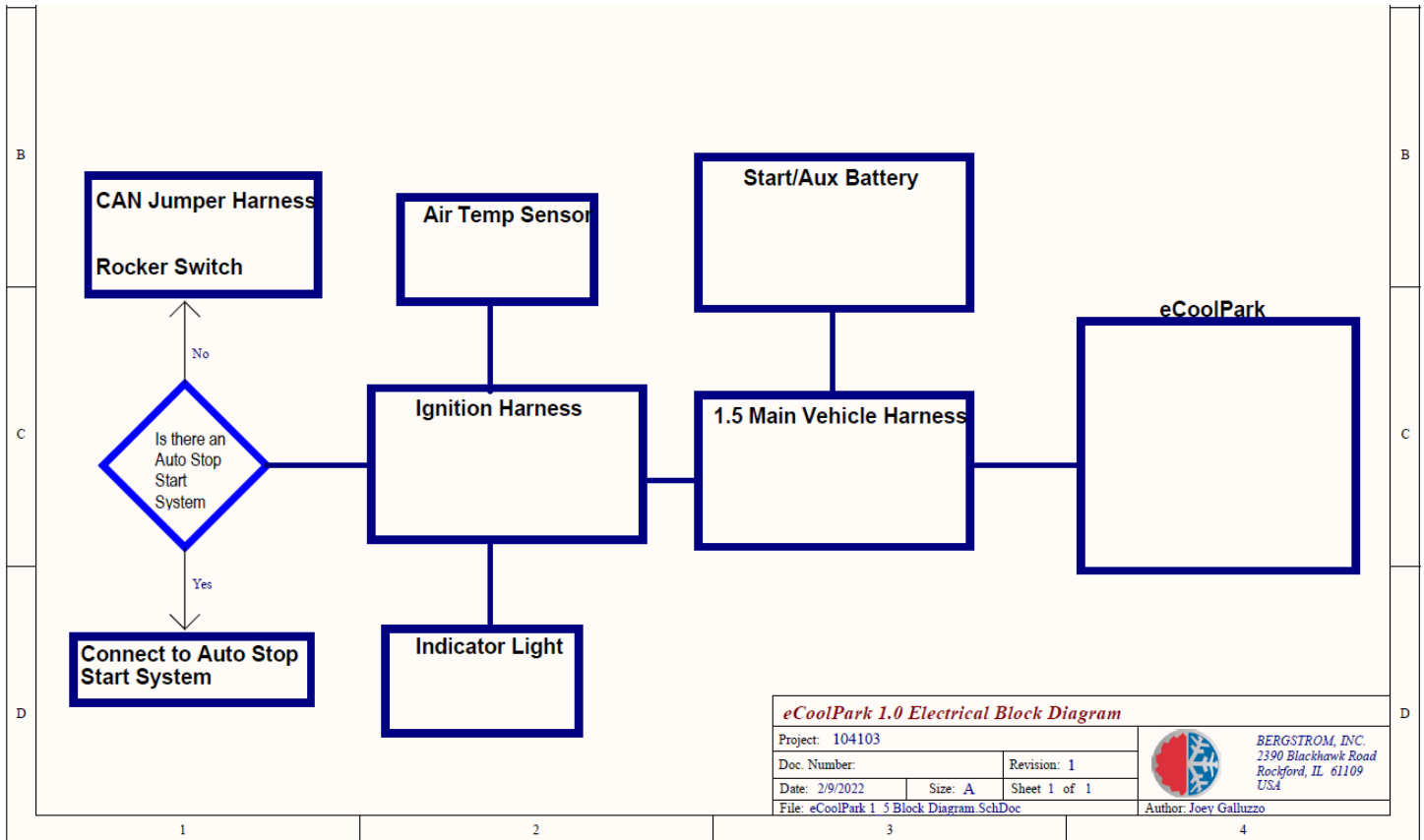

Figure 2.15: eCoolPark 1.5 Electrical Block Diagram

Electrical wiring diagram is subject to change. It may not be identical to the wiring for your specific vehicle.

Section 3

Operating Instructions

eCoolPark XT

Ford

Installation Manual



As of June 2026, all new eCoolPark units arrive pre-programmed per the vehicle type requested. If further adjustment of parameters is necessary, use the following installation procedure to install required software.

Installation Procedure (Only need to complete 1 time per upfitter):

Necessary Tools:

- Laptop
- Internet Connection

Open the zip folder for the tool using this link:

<https://www.bergstrominc.net/files/Tools/FieldCommissioningTool.zip>

Extract the files to a known location. Recommended: Create a new folder called “eCoolPark Field Configurable Tool” in the C: drive.

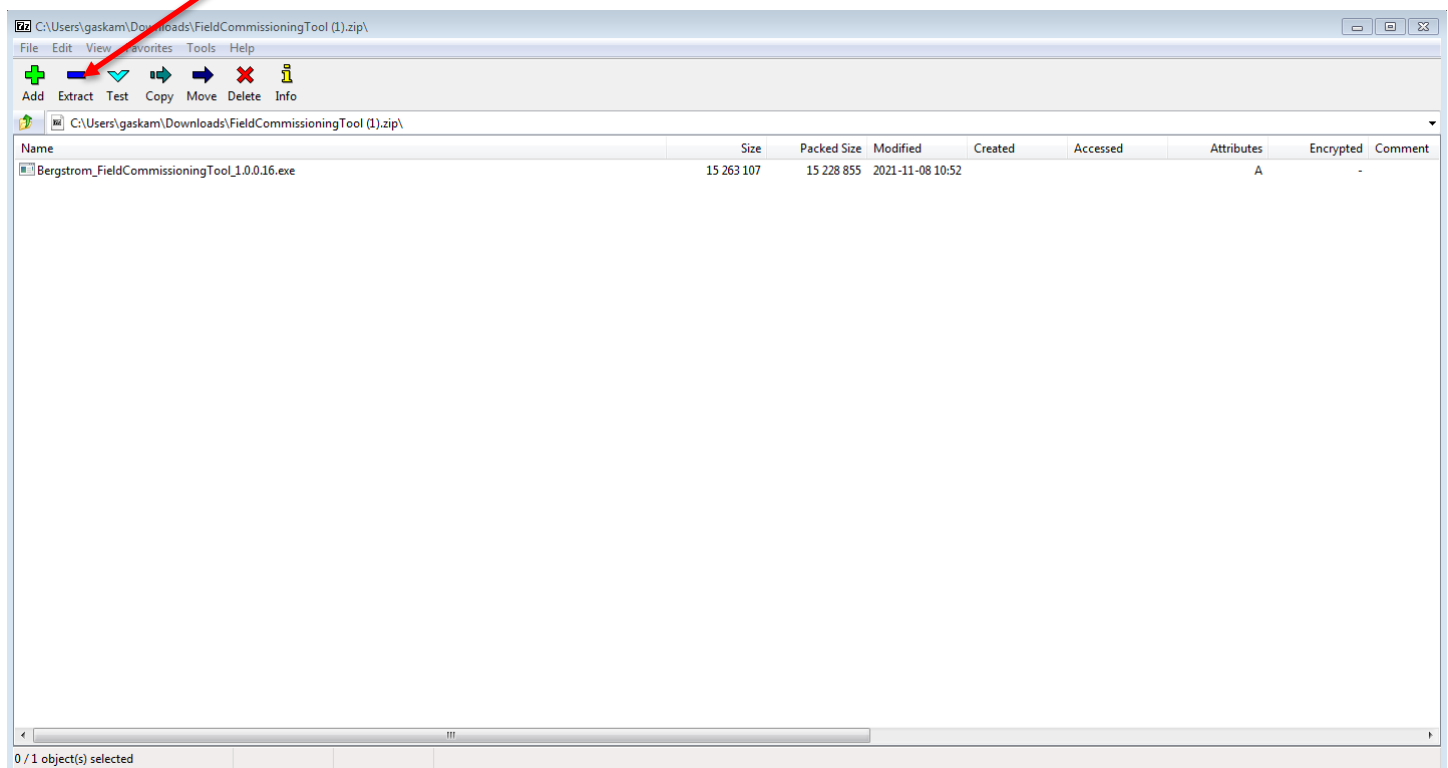

Locate and run the executable file in the folder where the tool was saved. Go through the installation process and save to the created eCoolPark folder.

Name	Date modified	Type	Size
 Bergstrom_FieldCommissioningTool_1.0.0.16.exe	11/8/2021 10:52 AM	Application	14,906 KB

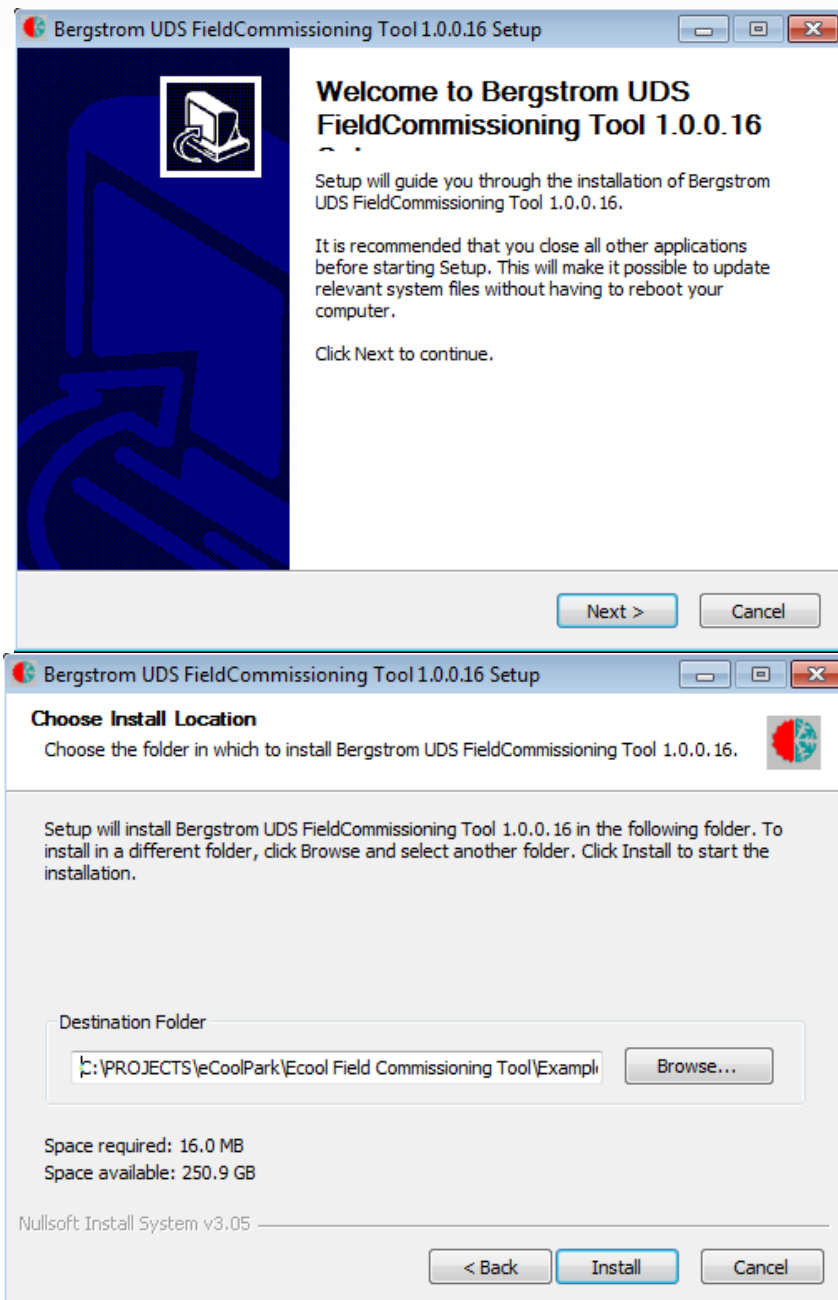

Confirm that the base configuration file is in the following location:
C:\Bergstrom_Commissioning

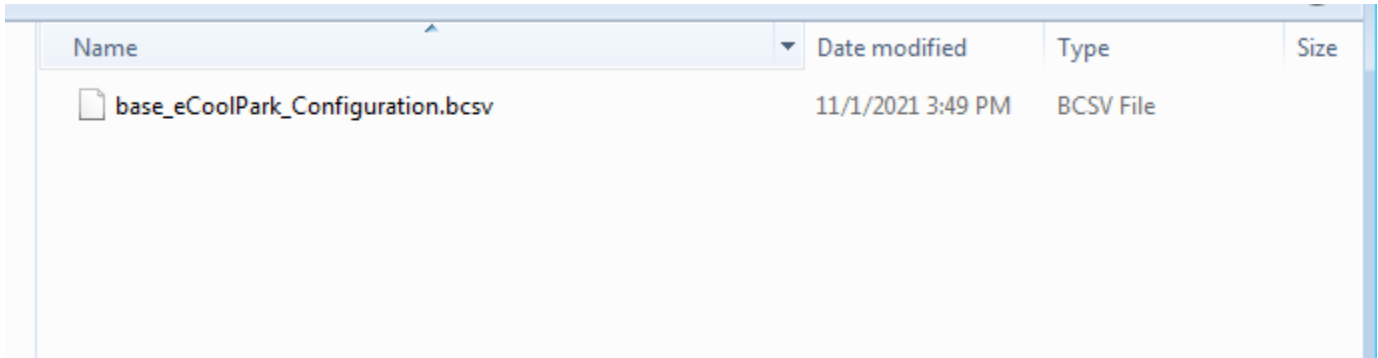

Name	Date modified	Type	Size
base_eCoolPark_Configuration.bcsv	11/1/2021 3:49 PM	BCSV File	

Download PCAN USB Drivers:

Relocate to: <https://www.peak-system.com/Drivers.523.0.html?&L=1>

Download the drivers for your respective system. Go through the installation process and make sure the download is successful.

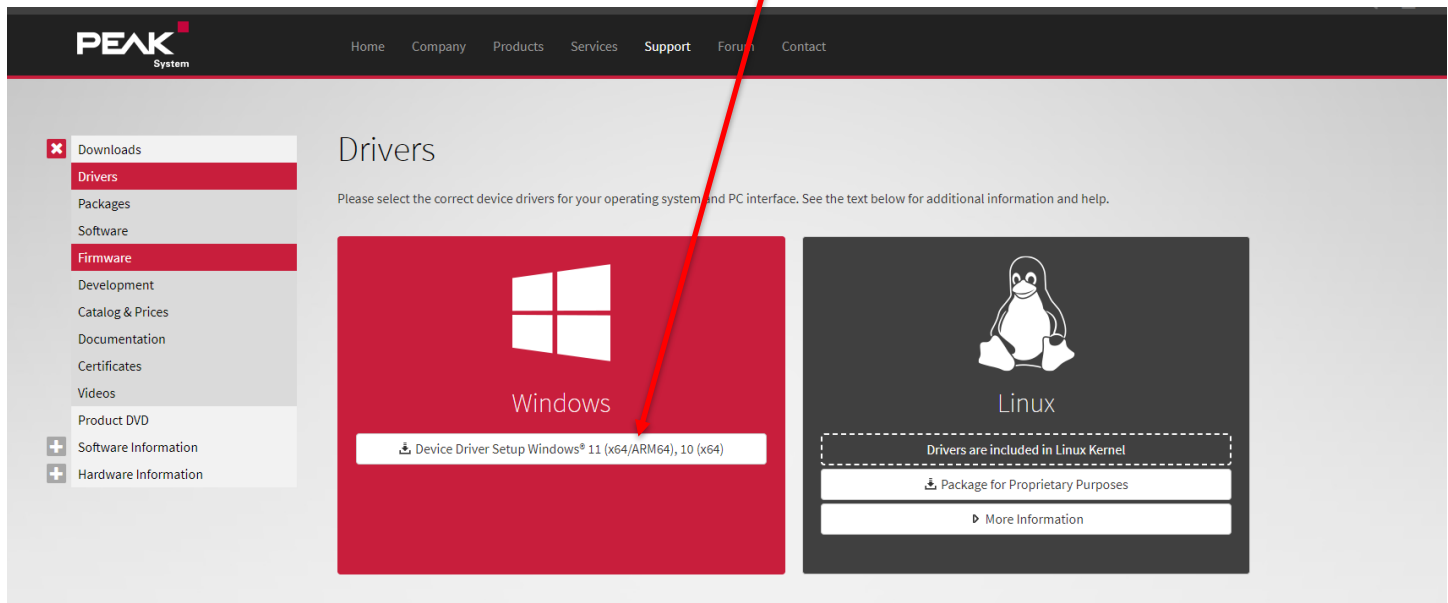

PEAK System

Home Company Products Services **Support** Forum Contact

Downloads
Drivers
Packages
Software
Firmware
Development
Catalog & Prices
Documentation
Certificates
Videos
Product DVD
+ Software Information
+ Hardware Information

Drivers

Please select the correct device drivers for your operating system and PC interface. See the text below for additional information and help.

Windows
Device Driver Setup Windows® 11 (x64/ARM64), 10 (x64)

Linux
Drivers are included in Linux Kernel
Package for Proprietary Purposes
More Information

Operational Procedure:

Necessary Tools:

- Laptop
- eCoolPark Electrical Service Kit - #1002839006 (By purchase or comes with cost of training)
- Downloaded software (Field Commissioning Tool and PEAK PCAN USB Drivers)

If at any time you get a **red** error message in the Application Response window, please check that all the software described above has been installed correctly. Make sure the system is getting proper power (12 or 24 VDC) when requested. Use multi-meter to check pin 1 power on 6-way HDP Deutsch connector at the eCoolPark unit (round connector pin 1).

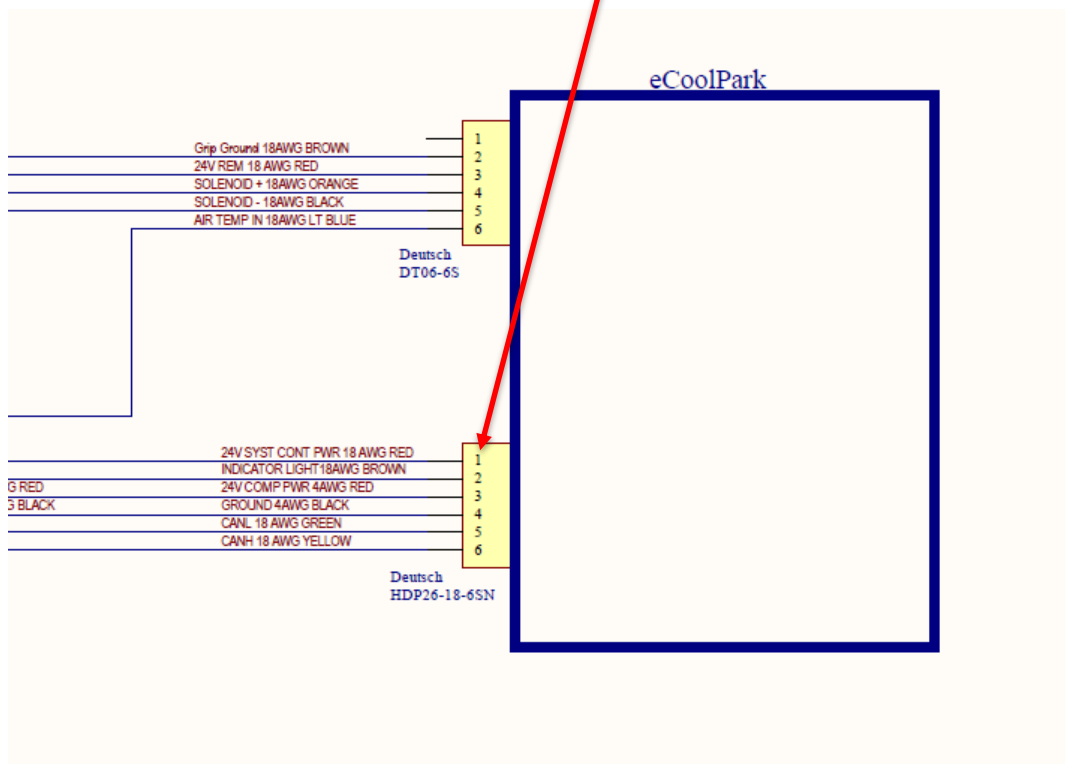

If necessary, contact a Bergstrom employee at: 1-866-204-8570

Connect the provided CAN to DB9 jumper harness to the ignition harness located in the driver under dash compartment using the 2-way CAN connector (Green and Yellow). Then connect your PCAN adapter to the harness via DB9 and to your computer via USB. Use termination resistors on the PEAK adaptor (provided).



Run the executable file containing the tool. (Make sure the rest of the files shown in the below picture are in the same location as the tool)

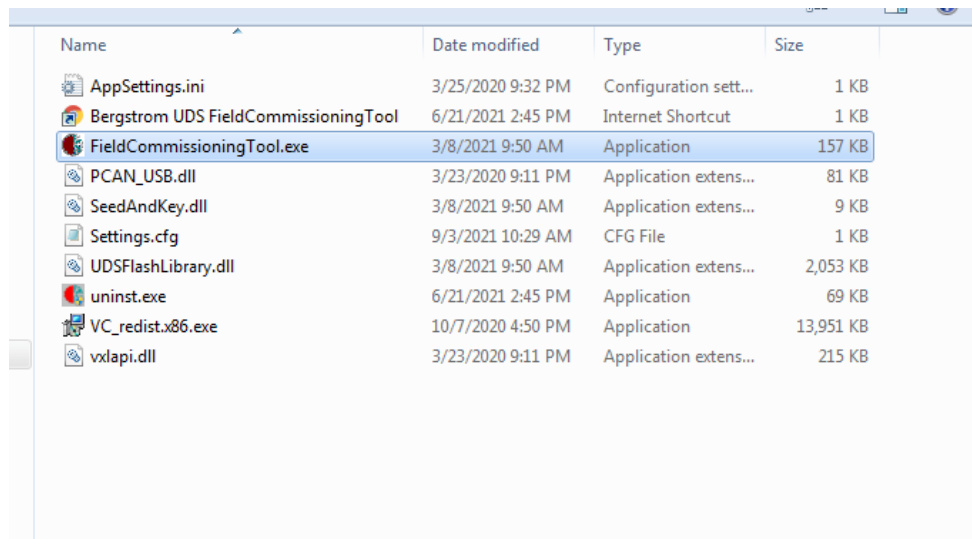

The default configuration file should open as shown.

If another configuration file is required (provided by Bergstrom upon request):
Use file -> Load Configuration to open the correct configuration file. (The tool will default to this configuration file, the correct file must be loaded in every time the tool is re-opened)

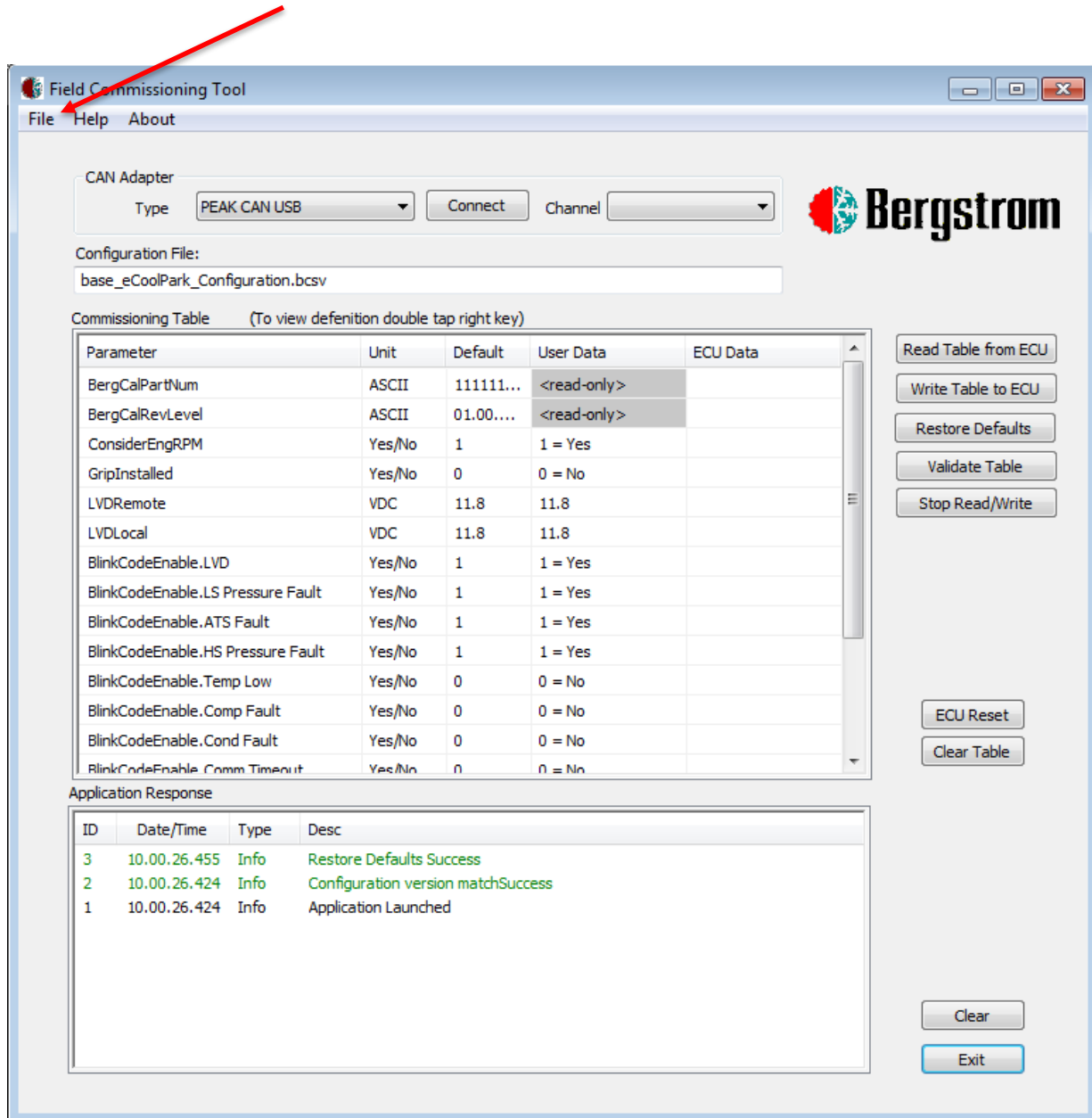

Make sure PEAK CAN USB is selected. Power on the eCoolPark system using the proper means for the vehicle (ex. rocker switch). Press “Connect” to connect to the Bergstrom ECU. The Application Response window should now display “Connect: Device Initialized” on top.

Field Commissioning Tool

File Help About

CAN Adapter
Type: PEAK CAN USB Disconnect Channel: Channel 1

Configuration File:
base_eCoolPark_Configuration.bcsv

Commissioning Table (To view definition double tap right key)

Parameter	Unit	Default	User Data	ECU Data
BergCalPartNum	ASCII	111111...	<read-only>	
BergCalRevLevel	ASCII	01.00.00	<read-only>	
ConsiderEngRPM	Yes/No	1	1 = Yes	
CondFanFreqReload	Integer	4000	4000	
CondFanFreqPrescaler	Integer	4	4	
CondFanPolarity	Yes/No	1	1 = Yes	
LVDRemote	VDC	11.8	11.8	
LVDLocal	VDC	11.8	11.8	
BlinkCodeEnable.LVD	Yes/No	1	1 = Yes	
BlinkCodeEnable.LS Pressure Fault	Yes/No	1	1 = Yes	
BlinkCodeEnable.ATS Fault	Yes/No	1	1 = Yes	
BlinkCodeEnable.HS Pressure Fault	Yes/No	1	1 = Yes	
BlinkCodeEnable.Cab Temp Low	Yes/No	1	1 = Yes	
BlinkCodeEnable.Comb Fault	Yes/No	1	1 = Yes	

Application Response

ID	Date/Time	Type	Desc
4	13.09.18.922	Info	Connect : Device Initialized
3	13.08.04.728	Info	Restore Defaults Success
2	13.08.04.712	Info	Configuration version matchSuccess
1	13.08.04.712	Info	Application Launched

Buttons: Read Table from ECU, Write Table to ECU, Restore Defaults, Validate Table, Stop Read/Write, ECU Reset, Clear Table, Clear, Exit

Press “Read Table from ECU”. Let the tool update and wait until the Application window prompts “Reading completed”. Upon success, this will fill in green data in the ECU data column. This data represents the current state of the parameters on the ECU.

The screenshot shows the 'Field Commissioning Tool' interface. At the top, there is a menu bar with 'File', 'Help', and 'About'. Below the menu bar, the 'CAN Adapter' section shows 'Type' set to 'PEAK CAN USB' and 'Channel' set to 'Channel 1'. A 'Disconnect' button is also present. The 'Configuration File' is 'base_eCoolPark_Configuration.bcsv'. The 'Bergstrom' logo is visible on the right side.

The main area contains a 'Commissioning Table' with the following data:

Parameter	Unit	Default	User Data	ECU Data
BergCalPartNum	ASCII	111111...	<read-only>	1111111111
BergCalRevLevel	ASCII	01.00.00	<read-only>	01.00.00
ConsiderEngRPM	Yes/No	1	1 = Yes	1 = Yes
CondFanFreqReload	Integer	4000	4000	4000
CondFanFreqPrescaler	Integer	4	4	4
CondFanPolarity	Yes/No	1	1 = Yes	1 = Yes
LVDRemote	VDC	11.8	11.8	11.8
LVDLocal	VDC	11.8	11.8	11.8
BlinkCodeEnable.LVD	Yes/No	1	1 = Yes	1 = Yes
BlinkCodeEnable.LS Pressure Fault	Yes/No	1	1 = Yes	1 = Yes
BlinkCodeEnable.ATS Fault	Yes/No	1	1 = Yes	1 = Yes
BlinkCodeEnable.HS Pressure Fault	Yes/No	1	1 = Yes	1 = Yes
BlinkCodeEnable.Cab Temp Low	Yes/No	1	1 = Yes	1 = Yes
BlinkCodeEnable.Comp Fault	Yes/No	1	1 = Yes	1 = Yes

To the right of the table are several buttons: 'Read Table from ECU', 'Write Table to ECU', 'Restore Defaults', 'Validate Table', 'Stop Read/Write', 'ECU Reset', and 'Clear Table'.

Below the table is the 'Application Response' section, which shows a log of events:

ID	Date/Time	Type	Desc
31	13.13.06.541	Info	Reading completed
30	13.13.06.541	Info	P: DisableIndEngOn Read Success
29	13.13.06.417	Info	P: TsetCompCutout Read Success
28	13.13.06.292	Info	P: TsetMaxCompSpd Read Success
27	13.13.06.167	Info	P: TsetMinCompSpd Read Success
26	13.13.06.042	Info	P: ConsiderRPMTimeout Read Success
25	13.13.06.917	Info	P: CANMessageType Read Success
24	13.13.06.793	Info	P: CANDataRate Read Success

At the bottom right of the application response section are 'Clear' and 'Exit' buttons.

To change a parameter: double click the parameter row in the “User Data” column. You can view the possible entries for the parameter and a description by double clicking the right key on the mouse (Do not need to change any parameters if using requested configuration file from Bergstrom).

The screenshot shows the 'Field Commissioning Tool' interface. At the top, there is a menu bar with 'File', 'Help', and 'About'. Below the menu bar, there is a 'CAN Adapter' section with a dropdown menu set to 'PEAK CAN USB', a 'Disconnect' button, and a 'Channel' dropdown set to 'Channel 1'. To the right of this section is the Bergstrom logo. Below the adapter section, there is a 'Configuration File' field containing 'base_eCoolPark_Configuration.bcsv'. The main area is titled 'Commissioning Table (To view defenition double tap right key)'. It contains a table with the following data:

Parameter	Unit	Default	User Data	ECU Data
BergCalPartNum	ASCII	111111...	<read-only>	1111111111
BergCalRevLevel	ASCII	01.00.00	<read-only>	01.00.00
ConsiderEngRPM	Yes/No	1	1 = Yes	1 = Yes
CondFanFreqReload				
CondFanFreqPrescaler				
CondFanPolarity				
LVDRemote				
LVDLocal				
BlinkCodeEnable.LVD				
BlinkCodeEnable.LS Pressure Fault				
BlinkCodeEnable.ATS Fault				
BlinkCodeEnable.HS Pressure Fault				
BlinkCodeEnable.Cab Temp Low	Yes/No	1	1 = Yes	1 = Yes
BlinkCodeEnable.Cmn Fault	Yes/No	1	1 = Yes	1 = Yes

A modal dialog box titled 'FieldCommissioningTool' is open over the 'ConsiderEngRPM' row. It displays the following information:

Parameter:
ConsiderEngRPM
Description:
0=don't consider RPM, 1= consider RPM

Buttons for 'Read Table from ECU', 'Write Table to ECU', 'Restore Defaults', 'Validate Table', 'Stop Read/Write', 'ECU Reset', 'Clear Table', 'Clear', and 'Exit' are visible on the right side of the interface.

Click “Validate Table” to verify all the entries made are valid. Upon success, click “Write Table to ECU”. Let the tool update and wait for the Application window to prompt “Writing Data completed”. Upon success, the ECU parameters have been updated. **Cycle power to the system to complete the process.**

Field Commissioning Tool

File Help About

CAN Adapter
Type: PEAK CAN USB Disconnect Channel: Channel 1

Configuration File:

Commissioning Table (To view definition double tap right key)

Parameter	Unit	Default	User Data	ECU Data
BergCalPartNum	ASCII	111111...	<read-only>	1111111111
BergCalRevLevel	ASCII	01.00.00	<read-only>	01.00.00
ConsiderEngRPM	Yes/No	1	1 = Yes	1 = Yes
CondFanFreqReload	Integer	4000	4000	4000
CondFanFreqPrescaler	Integer	4	4	4
CondFanPolarity	Yes/No	1	1 = Yes	1 = Yes
LVDRemote	VDC	11.8	11.8	11.8
LVDLocal	VDC	11.8	11.8	11.8
BlinkCodeEnable.LVD	Yes/No	1	1 = Yes	1 = Yes
BlinkCodeEnable.LS Pressure Fault	Yes/No	1	1 = Yes	1 = Yes
BlinkCodeEnable.ATS Fault	Yes/No	1	1 = Yes	1 = Yes
BlinkCodeEnable.HS Pressure Fault	Yes/No	1	1 = Yes	1 = Yes
BlinkCodeEnable.Cab Temp Low	Yes/No	1	1 = Yes	1 = Yes
BlinkCodeEnable.Comp Fault	Yes/No	1	1 = Yes	1 = Yes

Buttons: Read Table from ECU, Write Table to ECU, Restore Defaults, Validate Table, Stop Read/Write, ECU Reset, Clear Table

Application Response

ID	Date/Time	Type	Desc
59	13.21.04.482	Info	Writing Data completed
58	13.21.04.357	Info	P: DisableIndEngOnWrite comparison Success
57	13.21.00.833	Info	P: TsetCompCutoutWrite comparison Success
56	13.20.59.583	Info	P: TsetMaxCompSpdWrite comparison Success
55	13.20.59.334	Info	P: TsetMinCompSpdWrite comparison Success
54	13.20.58.335	Info	P: ConsiderRPMTimeoutWrite comparison Success
53	13.20.58.086	Info	P: CANMessageTypeWrite comparison Success
52	13.20.58.836	Info	P: CANDataRateWrite comparison Success

Buttons: Clear, Exit

Warning! All new eCoolPark units arrive pre-programmed per the requested vehicle type. If you need to adjust additional parameters, adjust manually per the rules listed below.

Vehicle or power source monitors engine RPM on its own (ex. Auto stop/start)

ConsiderEngRPM – “0 = No”

ConsiderRPMTIMEout – “0 = No”

BlinkCodeEnable.Comm TIMEout – “0 = No”

Vehicle has “Standard ID” CAN messaging (default is “1 = Extended ID”)

CANMessageType – “0 = Standard ID”

Vehicle CAN has 250k or 1M baud rate (default is “1 = 500K”)

CANDataRate – “0 = 250K” OR “2 = 1M”

If user does not want indicator light illuminated during vehicle engine ON (only if switch is left in ON position)

DisableIndEngOn – “1 = Disable indicator Light when engine is on”

Vehicle has older eCoolPark 24V unit (part number ending in 4442)

CondSpeedMin – “70”

CondSpeedMax – “100”

CondFanPolarity – “1 = Yes”

Additional parameters can be adjusted for customer preference. Examples include low voltage disconnect (LVD), compressor speed min and max, pressure cutouts, etc. Contact Bergstrom for additional support.

Testing eCoolPark Normal Operation:

1. Set the parking brake and turn the engine off – unit will only run if engine RPM is 0
2. Turn the key to the ignition ON position (do not start engine)
3. Set OEM control panel to: medium blower speed, recirculation, panel mode, and max cool. These initial settings will maximize system performance
4. Push the eCoolPark rocker switch to the ON position
5. Unit will run until any of the following conditions are met (default configurable parameters shown)
 - a. Rocker switch is turned off
 - b. Battery voltage drops below LVD (11.8 VDC for 12 V eCoolPark system)
 - i. Restart at 12.5 VDC
 - c. Cab air temperature sensor drops below 68 deg F (adjustable parameter)
 - i. Restart at 70 deg F
 - d. High side pressure goes above 275 psi
 - i. Restart after 30 seconds, condenser fan will stay on
 - e. Low side pressure drops below 20 psi
 - i. Restart at 35 psi, condenser fan will stay on

Normal Operation:

- Indicator light solid green
- Compressor running
- Condenser fan running (or cycling)
- OE evaporator blower running
- Cold air coming from louvers in cab



If normal operation is not achieved consult the troubleshooting section. Specifically, if the indicator light is blinking there is a fault in the system. Consult the fault code table in the troubleshooting section.

Breakdown of eCoolPark Logic:

1. ECU Operation – will verify proper conditions are set before running compressor/condenser
 - a. Battery voltage
 - b. Engine RPM
 - c. Cab air temperature range
 - d. Low pressure transducer range
 - e. High pressure transducer range
2. Compressor Operation
 - a. Cab air temp sensor – primary sensor to drive compressor
 - i. Will ramp compressor based off cab temperatures
 - ii. Once below cutout, a 2-degree F hysteresis is required before compressor enables again
 - iii. High pressure transducer high cutout is 275 psi
 - b. Low side pressure transducer – secondary sensor to drive compressor (will be primary if air temp sensor is disconnected or miss-wired)
 - i. Ramps compressor between 30 and 40 psi
 - ii. Low cutout is at 20 psi, compressor will restart at 35 psi

Note: Any time the compressor shuts off there is a minimum 30 seconds before compressor will restart unless power is cycled.

3. Condenser Operation
 - a. High side transducer – primary sensor to drive condenser
 - i. Will ramp condenser based on high side pressure
 - ii. Different ramping schemes based on which fan is in system
 - iii. High pressure transducer low cutout is at 100 psi. Startup at 105 psi.
 - b. Low side pressure transducer – secondary sensor to drive condenser (primary if fault in high side)
 - i. Ramps condenser from 30 to 55 psi
 - ii. Low pressure transducer low startup is at 35 psi

Section 4

Troubleshooting

eCoolPark XT

Ford

Installation Manual



If the eCoolPark unit is not operational, the following steps should be performed to check the wiring.

1. Start with the ignition harness and ensure power is being transmitted from the ignition harness into the main vehicle harness (from start battery add-a-fuse) – all steps should result in a reading of 12V.
 - a. Check battery voltage on ignition harness relay across orange (pin 1) and black (pin 2).
 - i. Possible Cause: add-a-fuse is not installed correctly or system control ground is not connected to battery negative.
 - b. If auto stop/start installed or there is an external enable, check battery voltage on ignition harness relay across purple (pin 5) and black (pin 2).
 - i. Possible Cause: auto stop/start or external enable is not sending 12 V signal or system control ground is not connected to battery negative.
 - c. If no auto stop/start or external enable, check battery voltage on ignition harness rocker switch across red (pin 3) and black (pin 7) – with rocker switch connected and latched to ON position.
 - i. Possible Cause: wiring issue or failed rocker switch.
 - d. Check battery voltage on the 6-way Deutsch connector across red (pin 1) and black (pin 5). This must be back probed while the ignition harness 6-way is mated to the main vehicle harness connector.
 - i. Possible Cause: wiring issue.
2. Check the voltages at the unit by removing the connectors from the unit and probing directly into the connectors
 - a. Check for battery voltage on round Deutsch connector across small red (pin 1) and black (pin 4).
 - i. Possible Cause: wiring issue.
 - b. Check for power source voltage on round Deutsch connector across large red (pin 3) and black (pin 4).
 - i. Possible Cause: power wires disconnected from battery or wiring issue.

If the unit still won't run after the previous step has been completed, it will be necessary to connect to the system over the CAN-bus.

To connect to the system CAN-bus you will need the following:

- Laptop
 - BUSMASTER installed – <https://rbei-etas.github.io/busmaster/>
 - PCAN-USB Drivers – <https://www.peak-system.com/>
- BUSMASTER configuration and database files
- Peak PCAN-USB with termination resistors
- CAN service jumper – purchased from Bergstrom Inc.
- System power

Complete the following:

1. Connect the CAN service jumper in-between the ignition harness and the main vehicle harness
2. Connect the Peak PCAN to the service jumper and laptop
3. Open Busmaster
4. Close trace window
5. Select load
6. Select “no” on dialog window
7. Locate correct configuration file and open
8. In the ribbon, select “Driver Selection” and make sure “Peak USB” is selected
9. In the ribbon, select “Database” select “Associate”
10. Locate correct database file and open.
11. Open Signal Watch and Transmit Window
12. Signal watch will tell you everything the eCoolPark unit is monitoring and outputting
13. Use transmit window to test override of compressor and condenser

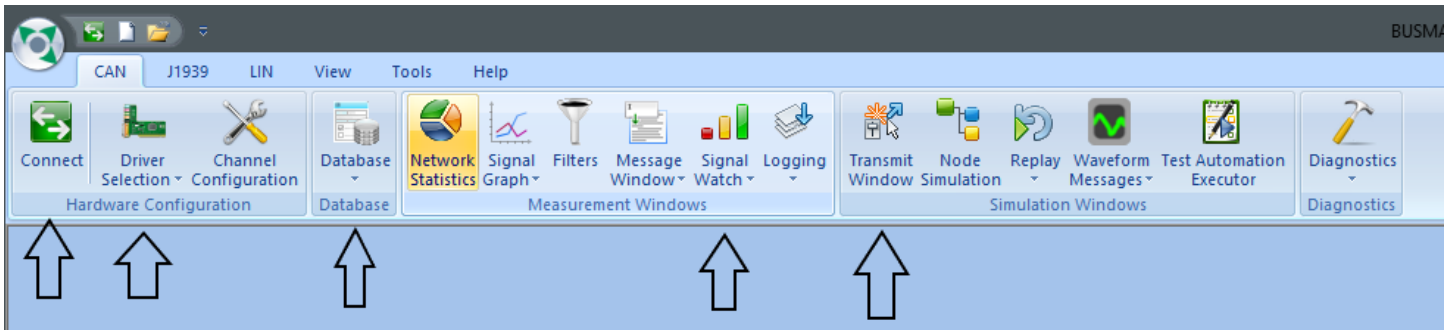
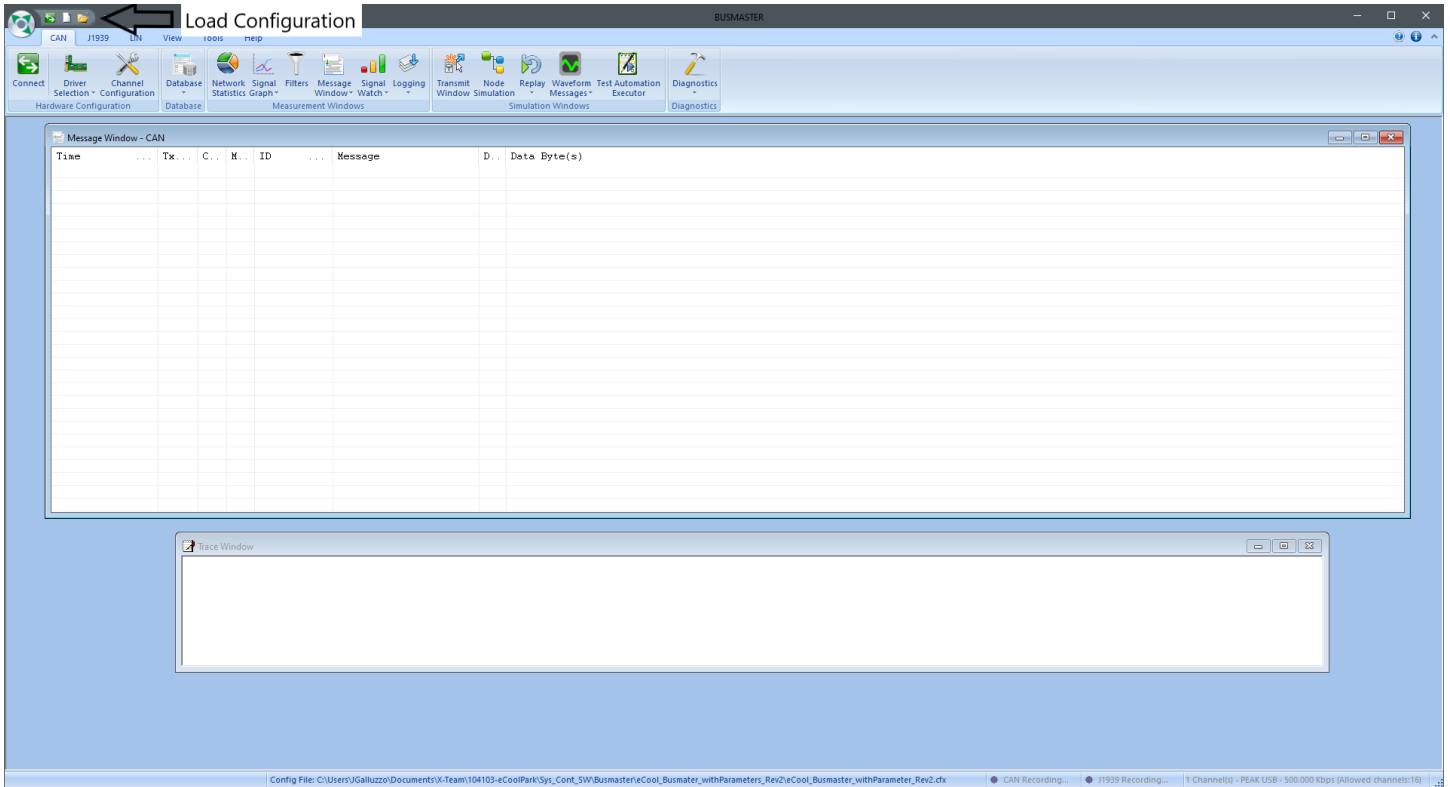

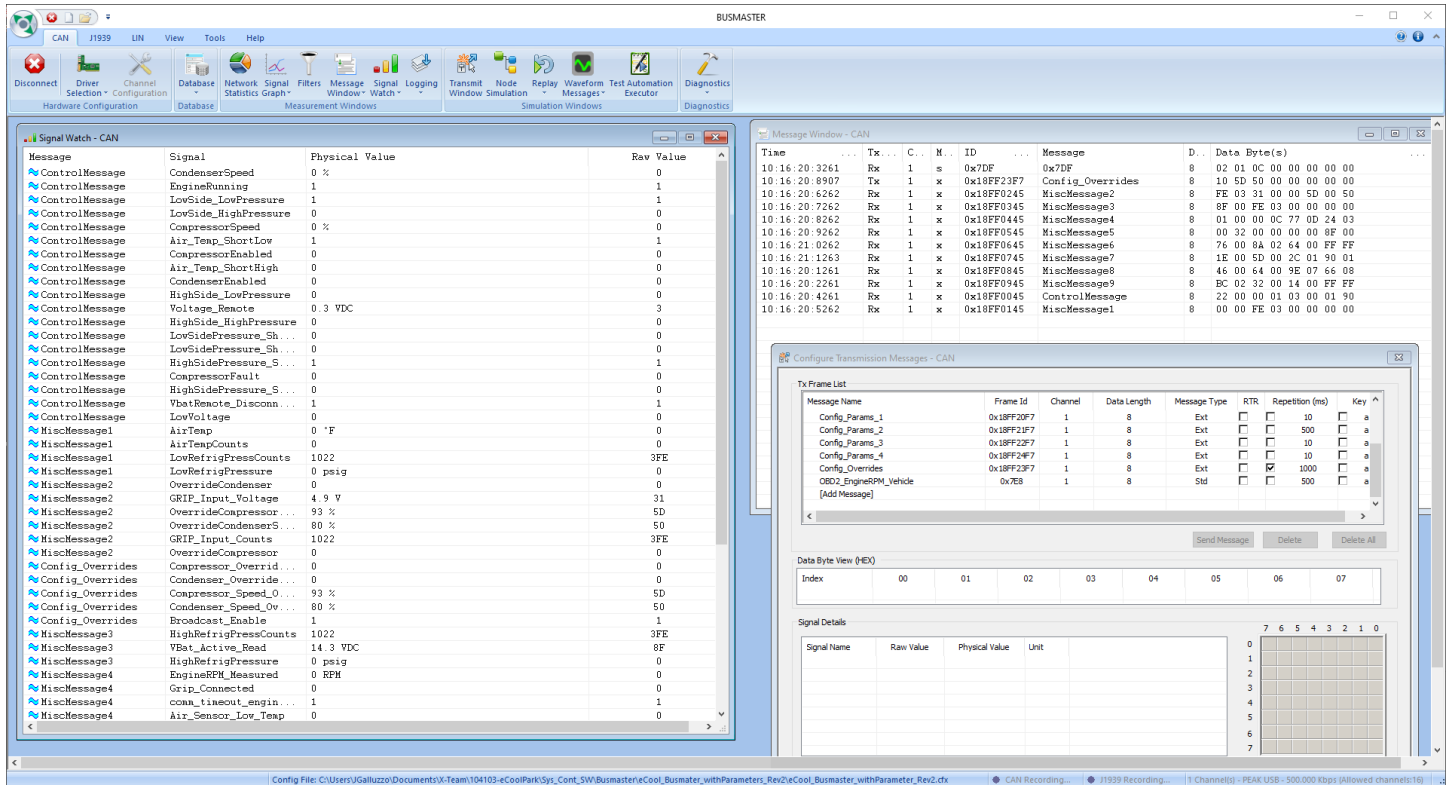

- Find the Config_Overrides row, select checkbox under “Repetition” column
- Under Signal Details, column “Physical Value”, change the corresponding row to a 1 to enable the compressor or condenser

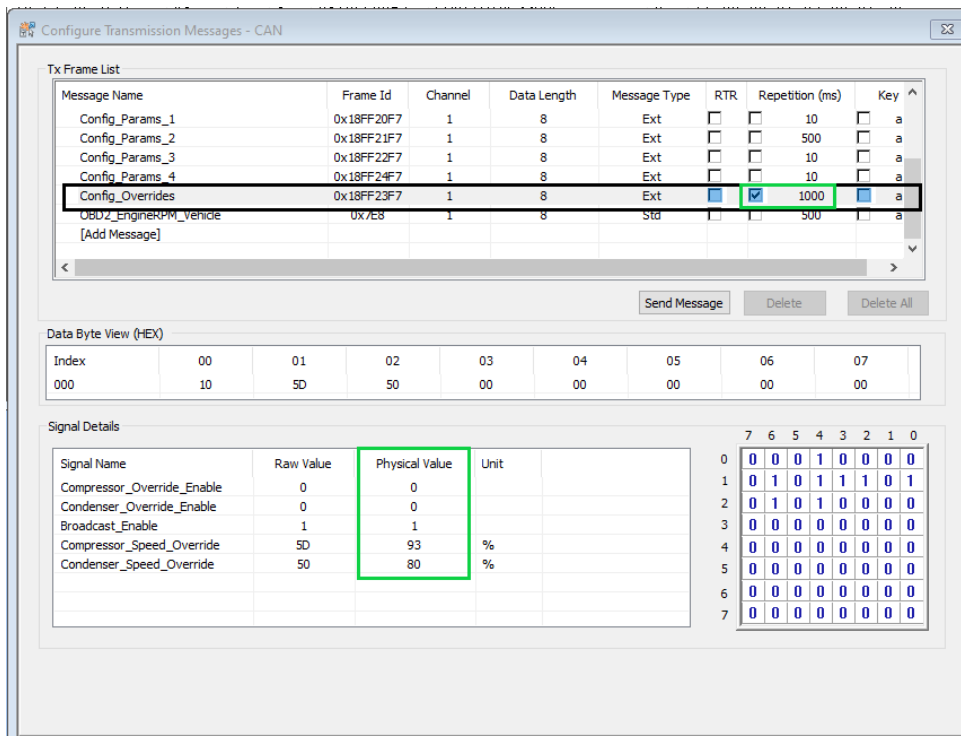

Fault Code List – Blinks on **Green** Indicator Light:

Code	Failure	Description
None	No faults – light solid green	System operation normal
1	LVD	Low Voltage Battery voltage fell below set low voltage disconnect parameter
2	Low Side Pressure Short Low/High Fault	Low side pressure fell below set LS low cutoff (default: 20 psi) Low side pressure rose above set LS high cutoff
3	Air Temp Sensor Short Low/High Fault	Air temperature sensor short Inspect or replace air temperature sensor
4	High Side Pressure Short Low/High Fault	High side pressure rose above set HS high cutoff (default: 275 psi) High side pressure fell below set HS low cutoff
5	Air Temperature Too Cold Status	Temperature in Cabin too low for A/C
6	Compressor Fault	Compressor malfunction
7	Condenser Fault	Condenser malfunction
8	Engine Speed Timeout	Lost connection to CAN Vehicle engine speed not reading
9	Ambient Temp Too Low	Ambient temperature too low
10	Compressor Lockout	Compressor seized Possible compressor failure

Bergstrom Technical Service Line: 1-866-204-8570

Section 5

Appendix





eCoolPark 1.5

Ford F550, F600

Installation Manual

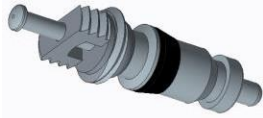

GRAPHIC	PART NUMBER	DESCRIPTION	N-m	In-lb	Ft-lb
	610099	Nut – Lock, 8mm	2.3±0.23	20±2	1.67±0.16
	621490	Nut – Keps, #10-32	2.3±0.23	20±2	1.67±0.16
	1001239680	Screw - #10-32 x ½” Machine	2.3±0.23	20±2	1.67±0.16
	1001520264	Nut – M5 x 0.8 Belleville	2.3±0.23	20±2	1.67±0.16
	1002522057	Screw - #10-14 x ½” Tri-Lobe	2.3±0.23	20±2	1.67±0.16
	1000341855	Nut – ¼-28 Serrated Hex Flange	3.4±0.34	30±3	2.5±0.25
	1001433139	Screw - #10-32 Hex Sems Conical Washer	3.4±0.34	30±3	2.5±0.25
	1001519699	Nut – M6 x 1 Belleville	7.0±0.7	62±6	5.17±0.5
	1002032563	Transducer, Pressure – Low Side	7.0±0.7	62±6	5.17±0.5

GRAPHIC	PART NUMBER	DESCRIPTION	N-m	In-lb	Ft-lb
	1002076692	Screw – Soc Hd Cap Screw M6-1.0x16 SS	7.0±0.7	62±6	5.17±0.5
	1002160852	Transducer, Pressure – High Side	7.0±0.7	62±6	5.17±0.5
	1002410443	Check Valve, Refrigerant – Schrader Core	0.45±0.045	4±1	0.33±0.08
	1002248234	Connector, Electrical – Hex Nut	5.6±0.5	50±5	4.17±0.42
	1002660607	M8 Bolt	21	186	15.5 ± 1



eCoolPark XT (engine off A/C) Operating Instructions

1. Turn vehicle engine OFF and key to RUN.
2. Set vehicle HVAC control panel to: medium blower speed, panel mode, recirculation mode, and max cool.
3. Activate eCoolPark with rocker switch (“Parked A/C”).
4. A/C system will run until:
 - a. Rocker switch is turned OFF.
 - b. Cab air temperature drops below set temperature (default: 68 F).
 - c. Vehicle engine turned ON.
 - d. High or low side pressure cutoff is reached.

<https://bergstrominc.com/us/ecoolpark-systems/>

1-866-204-8570



CERTIFICATE of Training



THIS CERTIFICATE IS PROUDLY PRESENTED
FOR BECOMING AN INTEGRATOR

COMPANY NAME
CITY, STATE

for completing the necessary training on the installation, operation and
service of an eCoolPark, thereby becoming an eCoolPark System Integrator

DATE

SIGNATURE